

USB Tesla Meter / Gauss Meter for PC with Analog Output

PC based microprocessor controlled precision Digital Tesla Meter / Gauss Meter

Model KOSHAVA-USB

Features:

- Min / Max detection (peak detection)
- Auto ranging
- Switchable units: Tesla, Gauss, kA/cm, A/cm or Oersted
- DC and AC Magnet field measurement up to 10 kHz RMS
- Digital linearization and Temperature compensate
- Free Software for remote and data logging
- LabVIEW examples for own applications
- Digital zero field adjustment
- 10 mG (1 μ T) Resolution
- 0.2% instrument accuracy
- RoHS conform (lead free)
- 3 years Warranty (mechanical damages excepted.)
- Include Factory Calibration Certificate
- Made in Germany



Description:

WUNTRONIC has expanded its hugely successful Tesla/Gauss Meter product family KOSHAVA with a new USB unit.

The Tesla/Gauss Meter KOSHAVA-USB is not only intended for customers which like to use the unit for automatically repeating pc based measurements, but also as a complement to the handheld Tesla Meter / Gauss Meter Type KOSHAVA 5, and also as a quality alternative for LowCost Tesla / Gauss Meters.

Probes can also be used with the KOSHAVA 5: The probes of the handheld Tesla Gauss meter KOSHAVA5 probes are compatible with the type of the KOSHAVA-USB.

High Quality Low-priced entry-level model: Most on the market available low cost Tesla / Gauss Meters are developed for consumer customers. Many professional customers with simpler measurement tasks are looking high quality and accurate alternative. The KOSHAVA-USB is available for the cheap price, but offers together with a PC the same accuracy and stability like the handheld device KOSHAVA 5

Always the optimal measurement range:

To be able to reach the optimal resolution always, the Tesla Meter / Gauss Meter KOSHAVA-USB is equipped depending of selected probe with 3 (20 mT, 200mT, 2T) or 4 (2mT, 20 mT, 200mT, 2T) measurement ranges. Probes with ranges up to 3 or 4 Tesla are on request available. The optimal measurement range can be either adjusted manually or setup automatically by using the Auto Ranging function.

Min / Max detection (Peak detection):

The Tesla meter /Gauss meter shows the minimal and maximal peak value in bottom area of the display. By pressing a key the peak values can be set to zero.

Precise in all measurement ranges:

In opposite to many other hall sensor based units at our Magnetometer KOSHAVA-USB each probe is measured in each range and

each probe gets an individual table with linearization and calibration information. At the first start with a new probe the Tesla / Gauss Meter reads the calibration information and use this for the accurate calculations of the measure values.

Analog output:

The Tesla Meter / Gauss Meter KOSHAVA-USB is suitable for the automatic control and documentation excellently through its features the analog output and USB interface. The software enclosed free of charge shows the displayed values of the device on the PC and offers the possibility saving the reading in a interval between 0,2 seconds to 50 seconds. The acquired data can be saved in the Excel compatible CSV format.

Applications:

- Assessment of magnetic materials.
- Analysis of magnetic circuits and components
- Measurement of residual magnetis
- Measure stray and leakage fields
- Measurement of absolute, and differential fields
- Testing, sorting, classifying magnets
- DC and AC motor testing
- Relay and solenoid test
- NDT Compliance Testing
- Loudspeaker test

Menu Control:

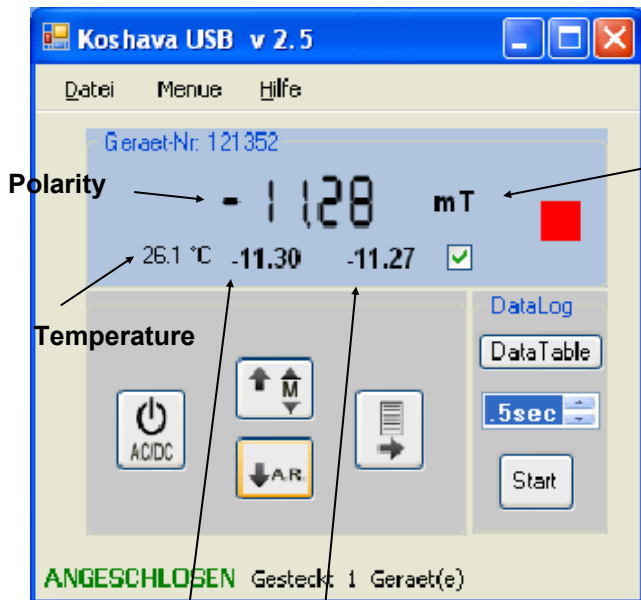

Polarity

Temperature

Minimal peak value

Maximal peak value

This function is very useful to find the maximum in magnet fields
By pressing a key the values can be set to zero

Units:

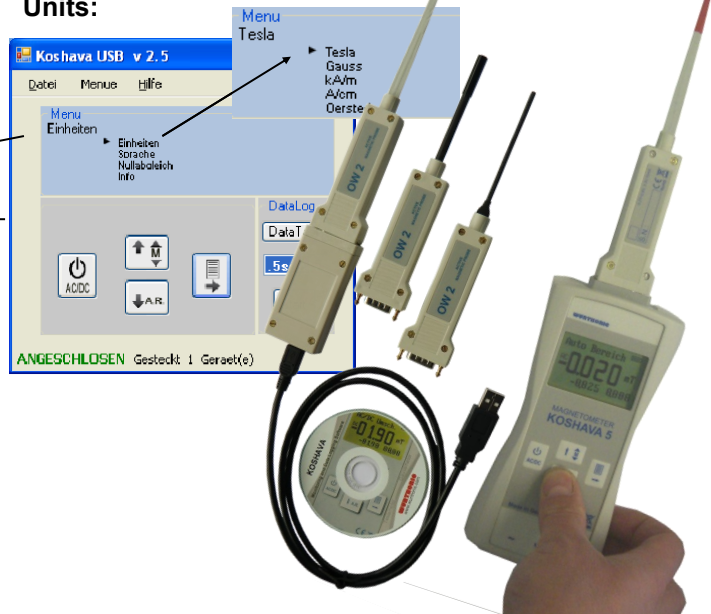

Analog output and USB interface: The Tesla Meters / Gauss Meters KOSHAVA are suitable for automatically control and documentation excellently because its features analog output and USB interface.

With the KOSHAVA Software the mixed use of up to 4 KOHAVA 5 or face-less KOSHAVA-USB units is possible.

For each unit, a data window opens, which shows the current value, the minimum and maximum peak and the temperature at the probe top.

The connected devices can be easily controlled on the control panel inspired by the KOHAVA5 control keypad

Connected Handheld Tesla / Gauss Meter KOSHAVA5 can be operated simultaneously on the device and the software



Data Streaming:

The measuring data of connected devices can be detected by a single device at intervals of 0.2 to 10 seconds and for more devices from 0.5 to 10 seconds. If you click the „Data Table“ key a detailed tables opens with all the measurement values.

The table can be exported as a text file.

122829 mT	DC °C	121359 T	DC °C	121352 mT	DC °C	121357 T	DC °C	08.10.2012
011.0	17.5	131.4	22.1	089.2	18.5	0.495	21.4	17:23:50.63
011.0	17.5	131.4	22.1	089.2	18.5	0.495	21.4	17:23:51.15
011.0	17.5	131.4	22.1	089.2	18.5	0.495	21.4	17:23:51.61
011.0	17.5	131.4	22.1	089.2	18.5	0.495	21.4	17:23:52.17
011.0	17.5	131.4	22.1	089.1	18.5	0.495	21.4	17:23:52.60
011.0	17.5	131.4	22.2	089.1	18.5	0.495	21.4	17:23:53.11
011.0	17.5	131.4	22.1	089.2	18.5	0.495	21.5	17:23:53.59
011.0	17.5	131.4	22.1	089.2	18.5	0.495	21.5	17:23:54.08
011.0	17.5	131.4	22.1	089.2	18.5	0.495	21.5	17:23:54.61
011.0	17.4	131.4	22.1	089.1	18.5	0.495	21.5	17:23:55.07
011.0	17.4	131.4	22.1	089.1	18.5	0.495	21.5	17:23:55.56

Probe selection Axial or Transverse ?

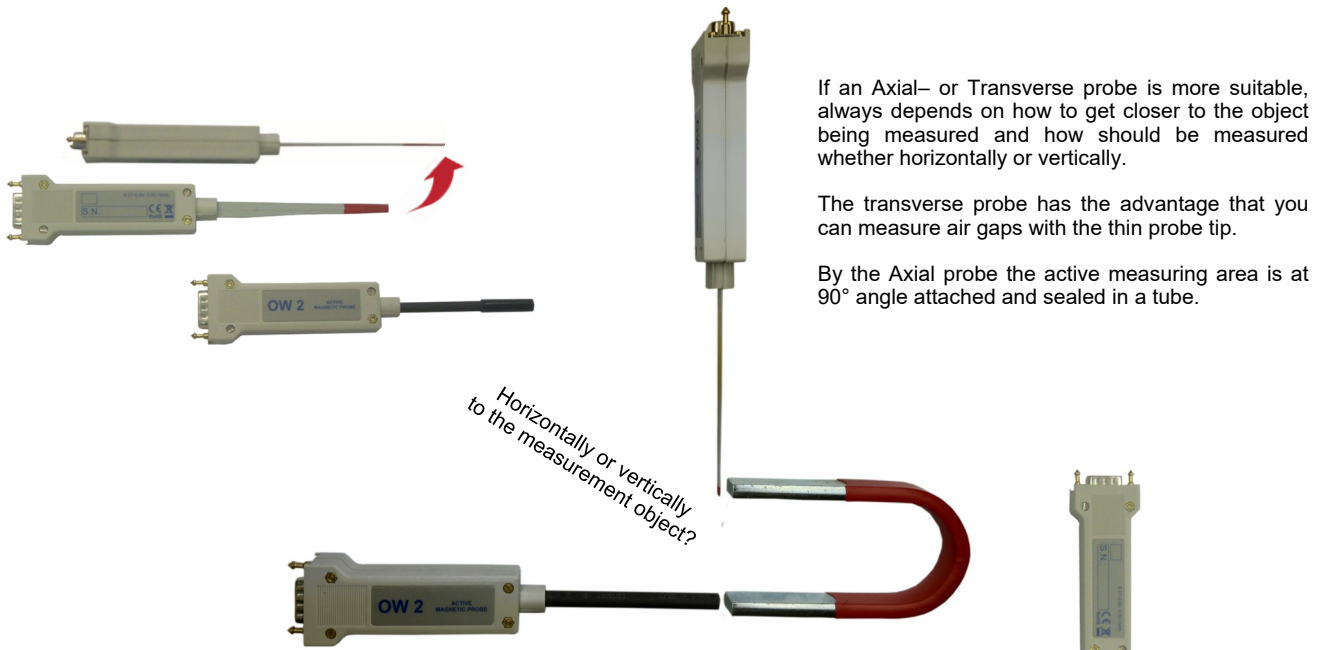

Probe dimensions:

Dimensions in mm:

Transverse probe

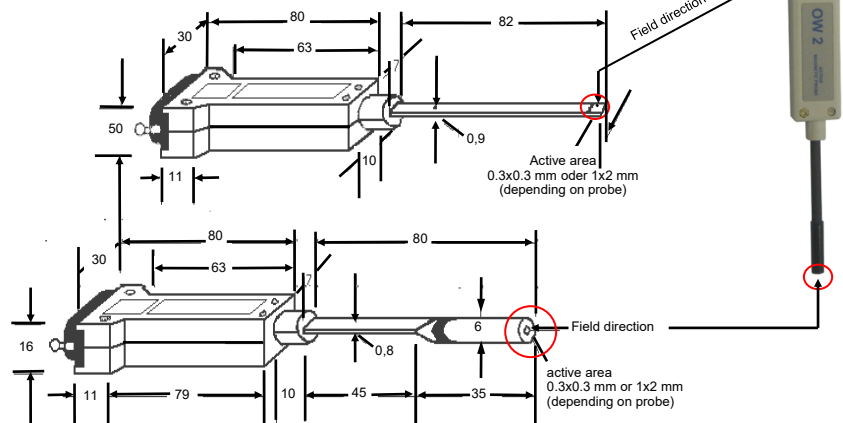

Axial probe

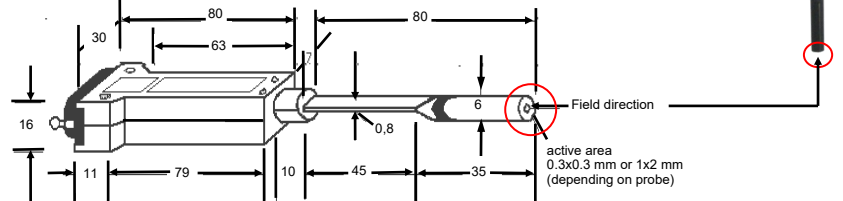

Scope of supply / Probe Options:

The probes are not include the scope of supply and must be ordered optional.



- **USB Tesla Meter / Gauss Meter** (Order number 1099355)
- **USB cable to connect to PC**
- **User manual in English and German language.**
- **Software for displaying and logging the measure values**
- **Calibration certificate**

Transverse Probes with 4 ranges:

Probes with 4 ranges and temperature sensor (Active area 1x2mm, accuracy DC $\pm 0,3\%$ AC $\pm 2\%$)

Ranges: 2mT, 20mT, 200mT, 2000mT
20Gauss, 200Gauss, 2kGauss, 20kGauss

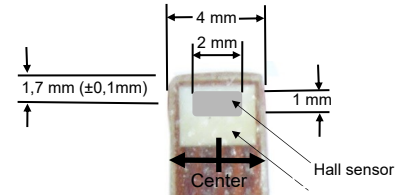
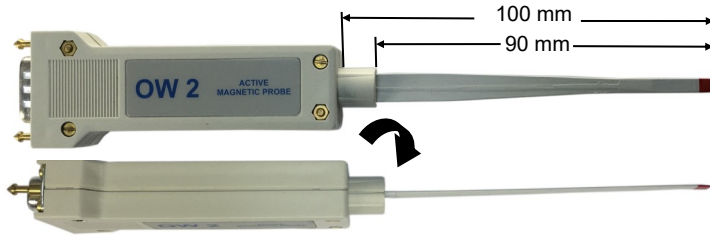

Order number	Model	Description
1099260	OW2-TT	Transverse probe for KOSHAHA 5 and KOSHAHA USB

Transverse Probes with 3 ranges:

Probes with 3 ranges and temperature sensor (Active area 1x2mm, accuracy DC $\pm 0,3\%$)

Ranges: 20mT, 200mT, 2000mT
200Gauss, 2kGauss, 20kGauss

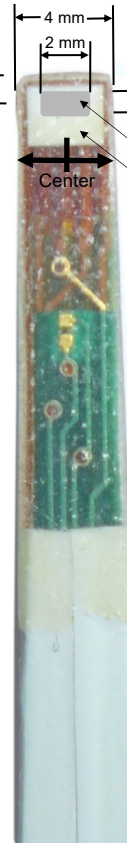
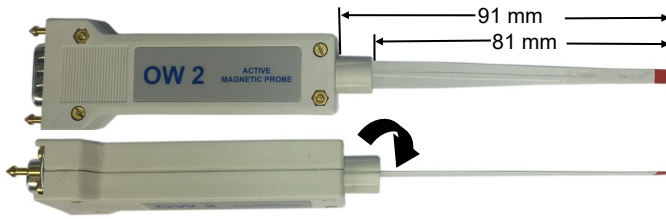

Order number	Model	Description
1099420	OW2-TT-3R	Transverse probe for KOSHAHA 5 and KOSHAHA USB

Transverse Probes with 3 ranges:

Probes with 3 ranges and temperature sensor (Active area 0,3x 0,3mm, accuracy DC $\pm 1\%$ AC $\pm 3\%$)

Ranges: 20mT, 200mT, 2000mT
200Gauss, 2kGauss, 20kGauss

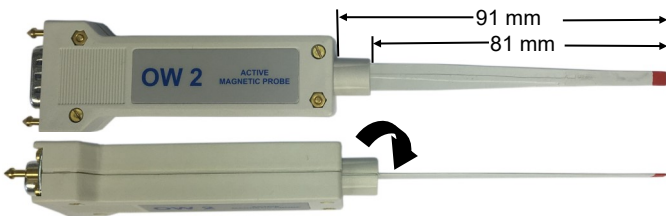

Order number	Model	Description
1099390	OW2-TMT	Transverse probe for KOSHAHA 5 and KOSHAHA USB

Axial Probes with 4 ranges:

Probes with 4 ranges and temperature sensor (Active area 1x2mm, accuracy DC $\pm 0,3\%$ AC $\pm 2\%$)

Standard probe

Order number	Model	Description
1099261	OW2-TA	Axial Probe for KOSHAVA 5 and KOSHAVA USB

Rugged probe with brass tube

Order number	Modell	Beschreibung
1099409	OW2-TMA-S	Axial probe for KOSHAVA-5 and -USB with 68mm probe length
1099410	OW2-TMA-M	Axial probe for KOSHAVA-5 and -USB with 28mm probe length

Axial Probes with 3 ranges:

Probes with 4 ranges and temperature sensor (Active area 1x2mm, accuracy DC $\pm 0,3\%$ AC $\pm 2\%$)

Standard Probe

Order number	Model	Description
1099430	OW2-TMT	Axial Probe for KOSHAVA 5 and KOSHAVA USB

Probes with 4 ranges and temperature sensor (Active area 0,3 x 0,3 mm, accuracy DC $\pm 0,3\%$ AC $\pm 2\%$)

Mini Axial Probe

Order number	Model	Description
1099409	OW2-TMA-S	Mini Axial Probe for KOSHAVA-5 and -USB with 32 mm probe length
1099410	OW2-TMA-M	Mini Axial Probe for KOSHAVA-5 and -USB with 68 mm probe length
1099415	OW2-TMA-L	Mini Axial Probe for KOSHAVA-5 and -USB with 202 mm probe length

Passive Probes :

For measurements with the whole probe in a strong magnetic fields such it happens for example in a MTR (magnetic resonance imaging) we developed the passive probes.

At the passive probe, the probe electronics is located at the end of the probe cable and be during the measurement away from the strong field.

The probe cable has a standard length of 2m and is optionally available with 4m.

The passive probes are available in the transverse and axial design.

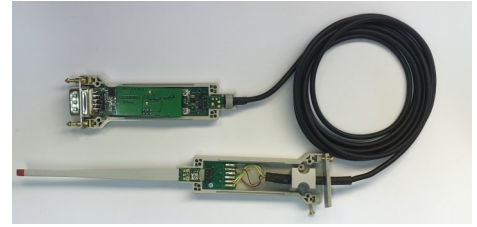

Passive Tranverse Probe :



Order number	Model	Description	Ranges
1099279	OW2-TT-P2.5	Passive Transverse Probe for KOSHAVA 5 and –USB	2,5mT, 25mT, 250mT, 2,5T
1099280	OW2-TT-P3	Passive Transverse Probe for KOSHAVA 5 and –USB	3mT, 30mT, 300mT, 3T
1099281	OW2-TT-P4	Passive Transverse Probe for KOSHAVA 5 and –USB	4T, 40mT, 400mT, 4T

Passive Axial Probe :



Order number	Model	Description	Ranges
1099289	OW2-AT-P2.5	Passive Axial Probe for KOSHAVA 5 and –USB	2,5mT, 25mT, 250mT, 2,5T
1099290	OW2-AT-P3	Passive Axial Probe for KOSHAVA 5 and –USB	3mT, 30mT, 300mT, 3T
1099291	OW2-AT-P4	Passive Axial Probe for KOSHAVA 5 and –USB	4T, 40mT, 400mT, 4T

Customized Probes:

Open probe tip for measurement into a air gap of 0.6 mm

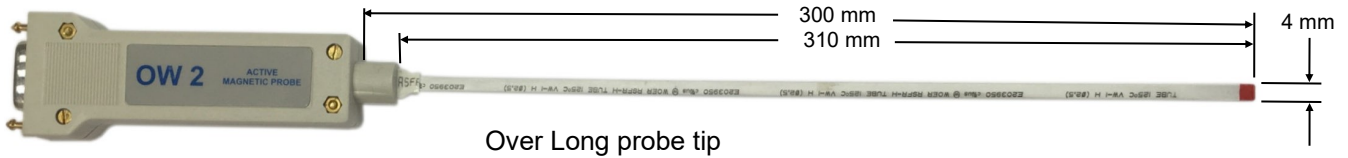

Zero Gauss Chamber:

The Zero-Gauss-Chamber insulate the environment magnet fields. The Zero field camber is very usefull for zero adjustments of Teslameters / Gauss meters.

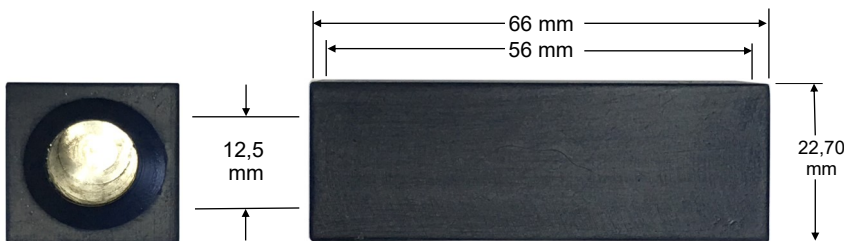

Order number	Model	Description
1099263	ZG-2	Zero Gauss Camber for Axial and Transverse Probes

Reference magnet:

The inexpensive WUNTRONIC standard reference magnets offers a simple way to test and calibrate in a defined field magnetic measuring instruments like our Gauss / Tesla Meters Series KOSHAVA.

For axial and transverse probes: The reference magnets MT Series can be used for transverse and axial probes.

The reference magnets are available in two versions with a magnetic flux density H (induction) 20mT (200 Gauss) or 180 mT (1800 Gauss).

The specified flux densities and field strengths are approximate values and are determined individually for each magnet.

Factory calibration certificate: The reference magnets are delivered as standard with a factory calibration certificate.

Optional DAkKS calibration: Optionally, the reference magnets are available with a DAkKS calibration certificate.

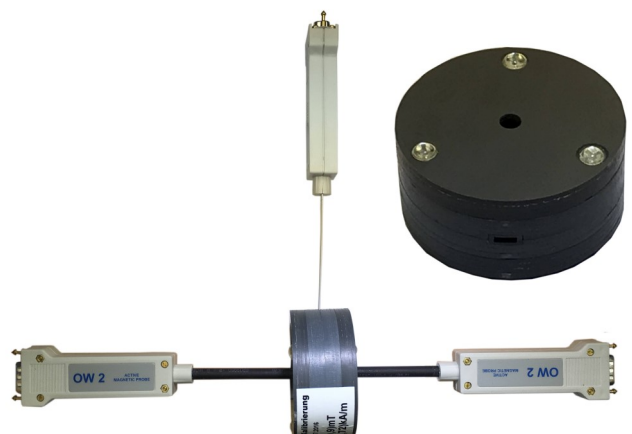

Order number	Model	Description
1099181	MT20mT	20mT (200 Gauss) Reference magnet with factory calibration certificate
1099182	MT180mT	180mT (1800 Gauss) Reference magnet with factory calibration certificate
1099190	MT-DAkKS	Optional DAkKS calibration (Calibration by DAkKS accredited calibration)

Specifications:

Measurement Ranges: 2 mTesla, 20mTesla, 200 mTesla, 2Tesla
 (depending of the probe) 20Gauss, 200Gauss, 2 kGauss, 20 kGauss
 1,591kA/m; 15,91kA/m; 159,1KA/m; 1,591MA/m
 15,91A/cm; 159,1A/cm; 1,591kA/cm; 15,91kA/cm
 20 Oersted; 200 Oersted; 2kOersted; 20 kOersted

Auto ranging The Tesla / Gauss Meter switch automatically in the optimal range

Display and switchable units : 3 ½ digit display .
 1,999 mT, 19,99 mT, 199,9 mT, 1999 mTesla
 19,99 Gauss, 199,9 Gauss, 1,999 kGauss, 19,99 KGauss
 1,591kA/m; 15,91kA/m; 159,1KA/m; 1,591MA/m
 15,91A/cm; 159,1A/cm; 1,591kA/cm; 15,91kA/cm
 19,99 Oersted; 199,9 Oersted; 1,999kOersted; 19,99 kOersted

Accuracy:
 Device 0,2% FSR ± 1 Digit
 Probe 0,3% FSR (DC) / 2% FSR (AC)

Long time stability: 0,1% per year
 Reproducibility: 0,1% FSR (Units and probe)
 Operating temperature: 10° C to + 45° C
 Storing temperature: -20° C to + 55° C
 Temperature coefficient: 0,01% F.S. per °C (Unit and probe)
 Functions: DC, negative and positive peak value AC,

Power supply:

Battery: 3 x1,5 volts AA Batteries (for approximately 70 hour operating)
 USB with external USB power supply or USB connection to PC

Dimensions and weight:

Dimension: Unit 165mm x 78 mm x 34 mm
 Weight: Unit 255 Gramm (incl. Batterie)
 Transvers probe 43 Gramm
 Axial probe 55 Gramm

Output and interface:

Analog output: ±800 mV F.S. up to 10 KHz not corrected
 Connection by 2,5 mm mono connector

Interface: USB 1.1
 Software Windows based Software for displaying and logging the measurement values at computer

Changes reserved

Order information:

Order No.	Model	Description	Accuracy DC	Accuracy AC
1099255	KOSHAVA 5	Precision Handheld Tesla / Gauss Meter (Please select one probe)		
1099355	KOSHAVA-USB	Faceless Precision Tesla / Gauss Meter (Please select one probe)		
Order No.	Model	Description	Accuracy DC	Accuracy AC
Probes with 3 ranges (20mT, 200mT, 2000mT) and temperature sensor (active area 0,3mm x 0,3mm):				
1099390	OW2-TMT	Transverse probe for KOSHAVA 5 and KOSHAVA-USB	±1% F.S	±3% F.S
Miniature axial probes with 3 ranges (20mT, 200mT, 2000mT) and temperature sensor (active area 0,3mm x 0,3mm):				
1099409	OW2-TMA-S	Mini axial probe (Probe top length 32mm and 3mm diameter) for KOSHAVA 5 and KOSHAVA USB	±1% F.S	±3% F.S
1099410	OW2-TMA-M	Mini axial probe (Probe top length 68mm and 3mm diameter) for KOSHAVA 5 and KOSHAVA USB		
1099415	OW2-TMA-L	Mini axial probe (Probe top length 202mm and 3mm diameter) for KOSHAVA 5 and KOSHAVA-USB		
Probes with 3 ranges (20mT, 200mT, 2000mT) and temperature sensor (active area 1mm x 2mm):				
1099420	OW2-TT-3R	Transverse probe for KOSHAVA 5 and KOSHAVA-USB	±0,3% F.S	±2% F.S
1099430	OW2-TA-3R	Axial probe for KOSHAVA 5 und KOSHAVA-USB		
Probes with 4 ranges (2mT, 20mT, 200mT, 2000mT) and temperature sensor (active area 1mm x 2mm):				
1099260	OW2-TT	Transversal probe for KOSHAVA 5 und KOSHAVA-USB	±0,3% F.S	±2% F.S
1099261	OW2-AT	Axial probe for KOSHAVA 5 und KOSHAVA-USB		
1099261-R	OW2-RAT	Axial probe for KOSHAVA-5 and -USB (Probe top length 68mm)		
1099261-R1	OW2-RAT1	Axial probe for KOSHAVA-5 and -USB (Probe top length 28mm)		
Passive probes (for using into strong magnetic fields) with 4 ranges (3mT, 30mT, 300mT, 3000mT) and temperature sensor (active area 1mm x 2mm):				
1099280	OW2-TT-P3	Passive Transverse probe for KOSHAVA 5 and KOSHAVA-USB	±0,3% F.S	±2% F.S
1099290	OW2-AT-P3	Passive axial probe for KOSHAVA 5 and KOSHAVA-USB		
1099281	OW2-TT-P4	Passive Transverse probe for KOSHAVA 5 and KOSHAVA-USB		
1099291	OW2-AT-P4	Passive axial probe for KOSHAVA 5 and KOSHAVA-USB		
Options:				
1099263	ZG-2	Zero field camber for transverse and axial probe		
1099181	MT20mT	Reference magnet ca.20mT (200 Gauss) for Transverse -and Axial-Probes		
1099182	MT180mT	Reference magnet ca.180mT (1800 Gauss) for Transverse -and Axial-Probes		
1099184	MT800mT	Reference magnet ca.800mT (8000 Gauss) for Transverse Probes		