



Torque Tube Liquid Level Transmitters and Controllers Series 8000-NO

Series 8000 pneumatic torque tube liquid level instruments utilize the buoyancy exerted on a displacer when immersed in a liquid. The buoyancy on the displacer is proportional to the **liquid level** and operates on a torque tube which, in turn, moves the pointer along the instrument scale.

This system is exceptionally accurate and friction-free as the torque tube acts also as sealing device towards the pressure of the process fluid whose level is being measured.

The instruments are provided with a system for the specific gravity compensation of the measured liquid. They can be also designed for the **interface or specific gravity service**.

Instruments series 8000-NO are available in different styles for external mounting on tank and offer different possibilities both for the process connections position and for the construction materials.

The instrument case, provided with a segmental graduated scale, is dust and spray proof and fitted with two pressure gauges for the compressed air supply and output signal respectively. Case internal pressurization is possible on request.

Compressed air for the instrument supply must be filtered, oil-free and sufficiently dry; a pressure of 1.4 bar (20 psig) is required.

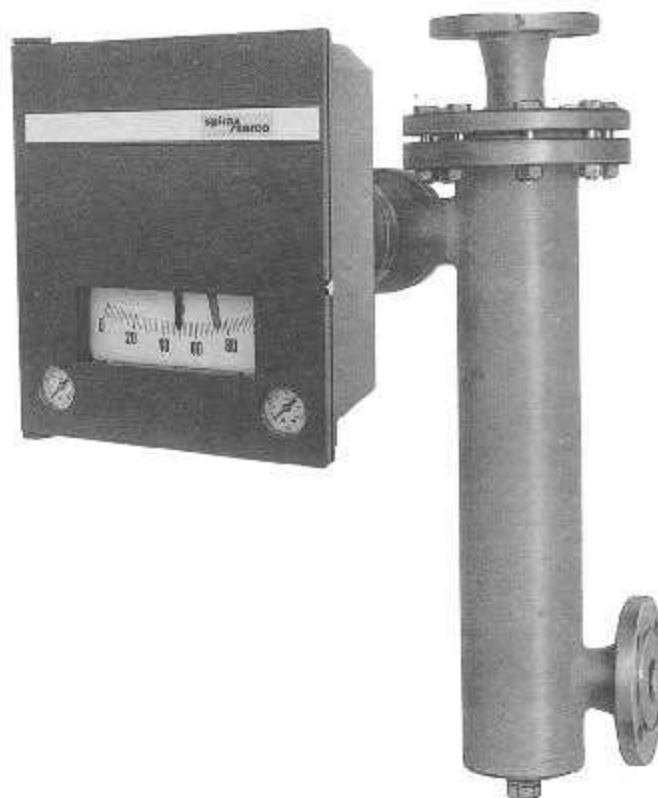

Fig. 1 - Liquid level instrument for external mounting.

DESIGN FEATURES

Mounting Styles

Series 8000-NO pneumatic torque tube liquid level controllers and transmitters are available in different styles for external mounting on tank.

Instruments are provided with a displacer cage which is fastened outside the tank by means of two connections located at different points; hence the instruments may be removed from the tank without interrupting the process if two shut-off valves are installed.

Mounting style is identified by the following suffixes:

- TF - displacer with external cage and top and bottom connections
- LL - displacer with external cage and side and side connections
- TL - displacer with external cage and top and side connections
- LF - displacer with external cage and side and bottom connections

For instruments without displacer cage and suitable for internal mounting on tank see bulletin 7B.221-E.

Rating, connections and materials

Instrument bodies, normally in contact with measured fluid or under pressure are **designed and rated according to UNI PN40**.

The **temperature limits** for the process fluid are: minimum -190°C and maximum 400°C ; for temperature over 110°C and below -20°C the use of an extension between the instrument case and torque tube device is required; the employed materials will be in accordance with the design limits.

The cage is normally provided with flanged connections DN 40 (1.1/2") size, rated according to UNI 2223-2229 PN40, flanges ANSI 300 RF are available with the limitation of cage design rating within the PN 40 standards.

Two inches size connections and/or tongues and grooves connecting flanges are available on request.

Other flanges are available on request with the limits imposed by the cage rating.

The normally employed **materials for cages** and torque tube case are:

carbon steel for temperatures ranging from -20°C to 300°C and **AISI 316 stainless steel** for low or high temperatures and for corrosive fluids.

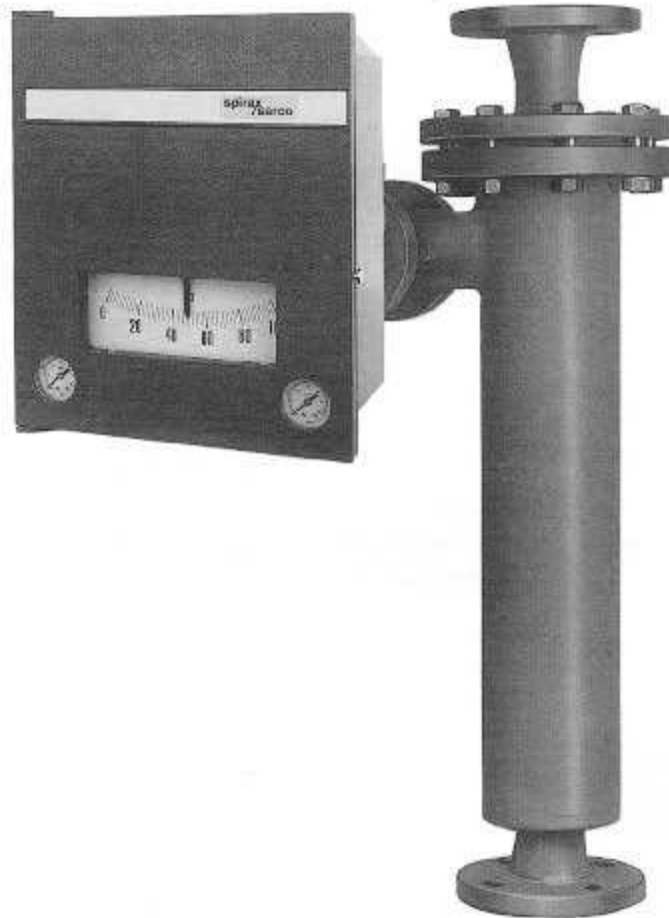

Fig. 2 - Instrument for external mounting with top and bottom connections.

Torque tube

The torque tube assembly is normally fabricated in AISI 316 stainless steel and its design is such that it ensures perfect torsional elasticity with no hysteresis thereby achieving instantaneous and accurate response to the torque produced by the buoyancy exerted on the float. The stainless steel keeps its own characteristics of elasticity also at the lowest temperatures. Inconel torque tubes are used for temperatures of the measured fluid exceeding 250°C or for peculiar problems of corrosion.

Teflon lining is possible for corrosive service on request.

Displacer

Displacers used in series 8000 liquid level instruments are of cylindrical shape and normally of AISI 316 stainless steel; displacers made in special materials are used for applications with particular problems of corrosion.

Teflon lining is available.

Displacer length determines the measurement range (maximum level excursion which may be measured).

Standard displacer lengths are as follows:

14" (356 mm)	72" (1829 mm)
20" (508 mm)	84" (2134 mm)
24" (610 mm)	96" (2439 mm)
32" (813 mm)	108" (2743 mm)
48" (1219 mm)	120" (3048 mm)
60" (1524 mm)	

Displacer diameter depends on the measuring range and on the specific gravity of the liquid. The upper part of the displacer rod is provided with a friction free ball joint for quick connection to the torque arm.



Fig. 4 - Displacer and torque tube unit.

Case arrangement

Series 8000 transmitters and controllers are normally supplied with instrument case left hand mounted to the displacer vertical axis (standard execution) or right hand mounted on request.

Thanks to the special design of these instruments, case position may be reversed without being necessary to replace parts.

Peculiarity of instruments series 8000-NO is the torque tube system fitted directly on the displacer cage so the instruments case is placed in a fixed position and can not be swung. For the rotatable construction see bulletin 7B.221-E.

Specific gravity compensation adjustment

As the buoyancy exerted on the displacer varies with the liquid specific gravity, in order to ensure that the liquid level travel from bottom to top of the displacer exactly corresponds to the pointer movement through the full scale of the instrument, the torque tube shaft end is connected to the pointer through a linkage system including an adjusting device.

This device permits adjustment of the pointer stroke in accordance with the specific gravity of the liquid. The instrument may be easily calibrated in the field.

The standard adjustment ranges for the specific gravity are:

0.5 to 1.1 0.8 to 1.3 1.2 to 1.7

INTERFACE MEASUREMENT

Interface is defined as the boundary surface between two immiscible liquids, with different specific gravities; for instance as found in a tank containing water and petrol. The interface occurs in an intermediate zone of the displacer which must function completely submerged.

The buoyancy which determines the measurement, depends not only upon the interface level, but also on the difference in specific gravities of the liquids. Consequently special displacer and special torque tube, if necessary, will have to be provided.

SPECIFIC GRAVITY MEASUREMENT

Similarly to the interface level measurement, the displacer is fully submerged. Hence the buoyancy varies according to the specific gravity of the liquid and is independent from the level. Displacer dimensions are dependent on the desired range of the specific gravity.

TRANSMITTING INSTRUMENTS

They are designed to measure a liquid level or an interface level or a specific gravity indicating it on a segmental graduated scale; at the same time the measured variable is converted into a linear 0.2 to 1 bar or 3 to 15 psi pneumatic signal which is in turn transmitted to a receiver for remote indication, recording and/or an automatic control.

The case is identical to that of series 4000 instruments of which the same transducing elements are used.

These instruments find wide application in pneumatic transmitting systems for centralized measurement and control of processes.

A high capacity built in amplifying relay allows signal transmission, even over considerable distance, with minimum air consumption.

The transmitted signal is directly proportional to the measured value with remarkable accuracy, repeatability and sensitivity due to the feedback device of the transmitting unit.

The series 8000 pneumatic transmitters are available in the one single type 8095.

CONTROLLER INSTRUMENTS

They are designed to measure a liquid level or an interface level or a specific gravity indicating it on a segmental graduated scale; at the same time the measured variable is automatically controlled by means of a pneumatic control unit operating a control valve or any other pneumatic actuator.

The case is identical to that of series 4000 instruments of which the same amplifying and control elements are used.

Standard versions are equipped with a manually adjustable set point but also pneumatically or electrically adjustments of it are available for remote operation allowing the following facilities:

- manual remote set point adjustment by means of a manual loading station
- automatic set point adjustment from a master controller in cascade control loops
- automatic set point adjustment by a programme transmitter.

The control units are available in different versions for proportional with manual reset (P), proportional plus integral (PI) and proportional plus integral plus derivative (PID) control mode respectively; for on-off service the controllers are provided with a two-posi-

tion pneumatic control unit with adjustable differential gap, or with on-off control unit with non adjustable narrow differential gap.

Each control mode is easily adjustable by means of graduated dials. Also the action of the unit (direct or reverse) can be easily set in the field by means of the proportional band adjustment dial.

COMBINED TRANSMITTING AND CONTROLLING INSTRUMENTS

The transmitting plus controlling instruments represent a particular execution in the series 8000 instruments.

In the same case a transmitting unit and a controlling unit are housed and are operated by a single displacer.

As for the other instruments, the case is dust and spray proof and designed for external mounting; it is also fitted with two pressure gauges to display the transmitting signal (to the right) and the control signal (on left).

In these applications, compressed air supply pressure (20 psig) is indicated by the pressure gauge of the air filter regulator.

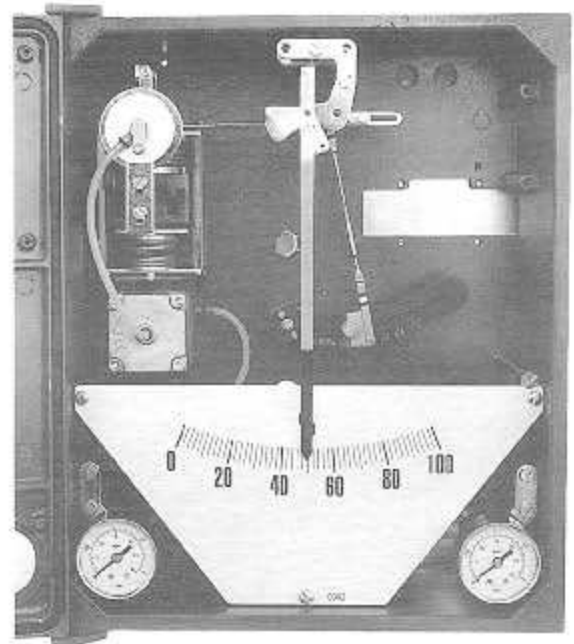
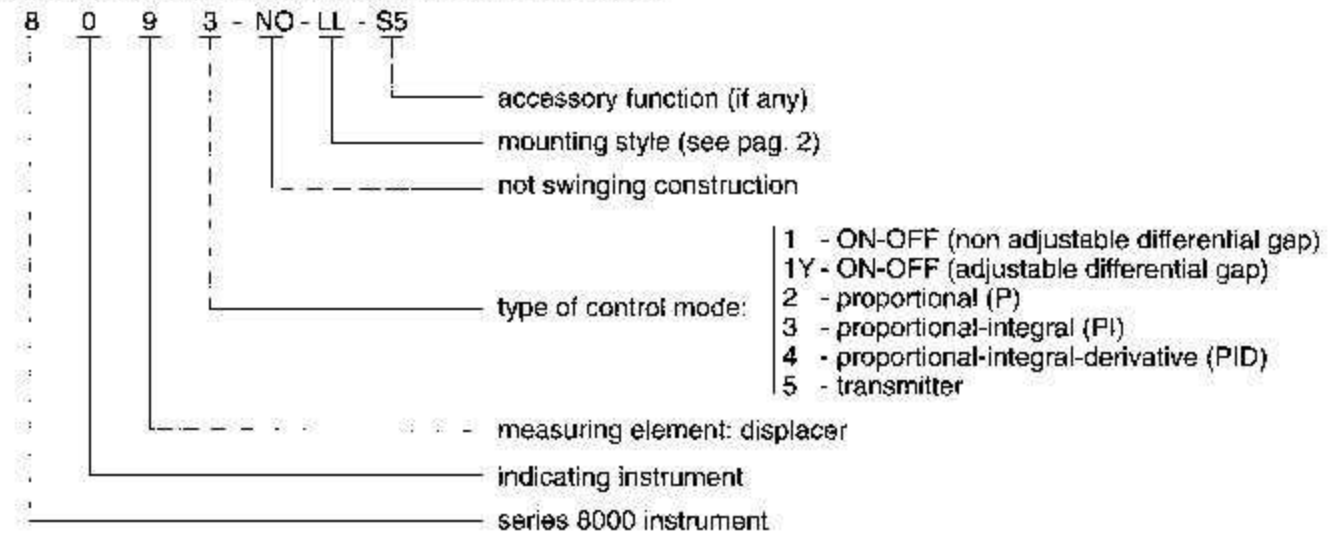

Fig. 4 - Inside view of transmitter case.

The **type number**, which identifies the general characteristics of the instrument, is composed by a number of four digits followed by an alphanumerical suffix. The meaning of digits and letters for an **instrument with one unit only** (controller or transmitter) is explained with an example:



The suffix, besides pointing out the mounting style, is used in order to complete or give complementary information about the instrument characteristics (i.e. S5 means that the instrument is fitted with a pneumatic adjustable set point); for the **instruments with combined functions** the suffix is also used to identify the control unit type and to point out the presence of a transmitting unit, for example:

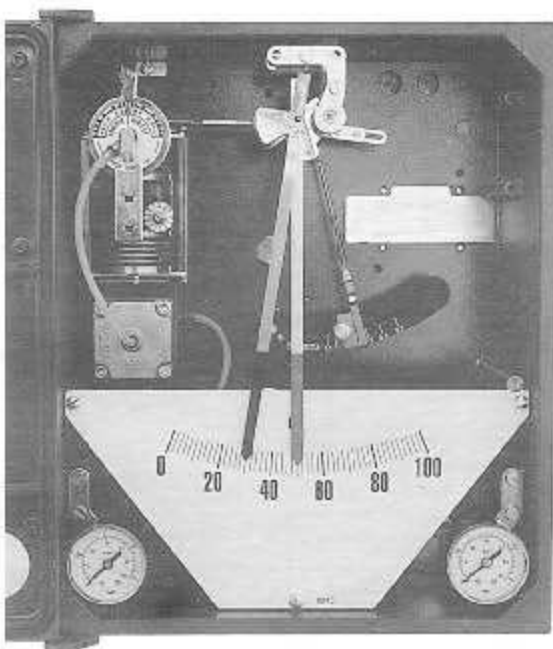
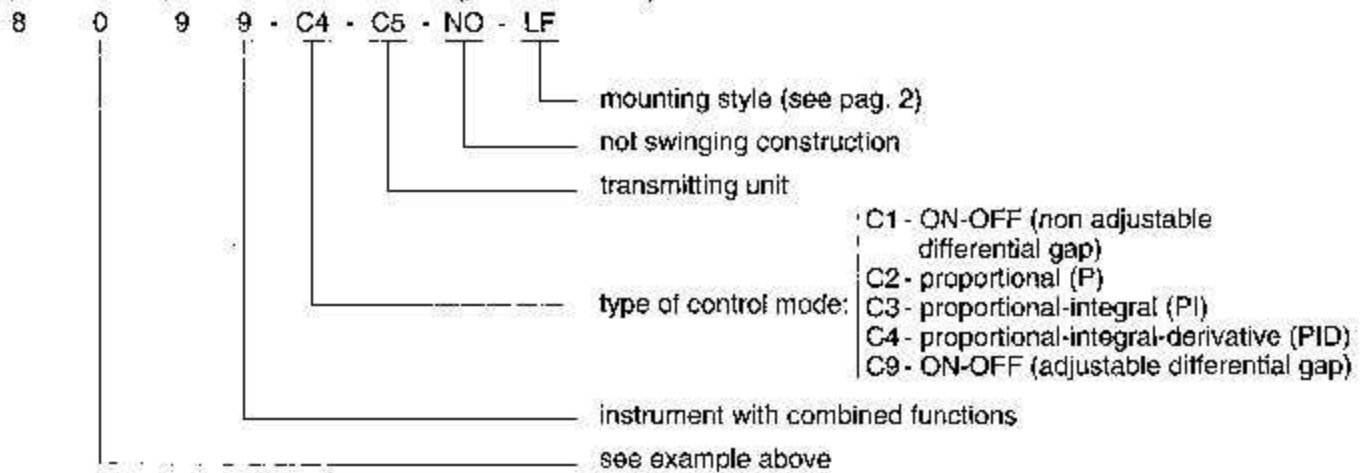

Fig. 5 - Inside view of controller case.

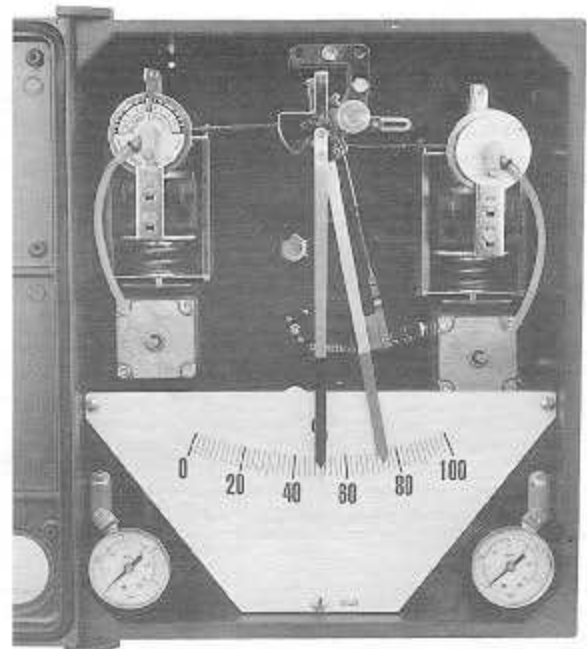
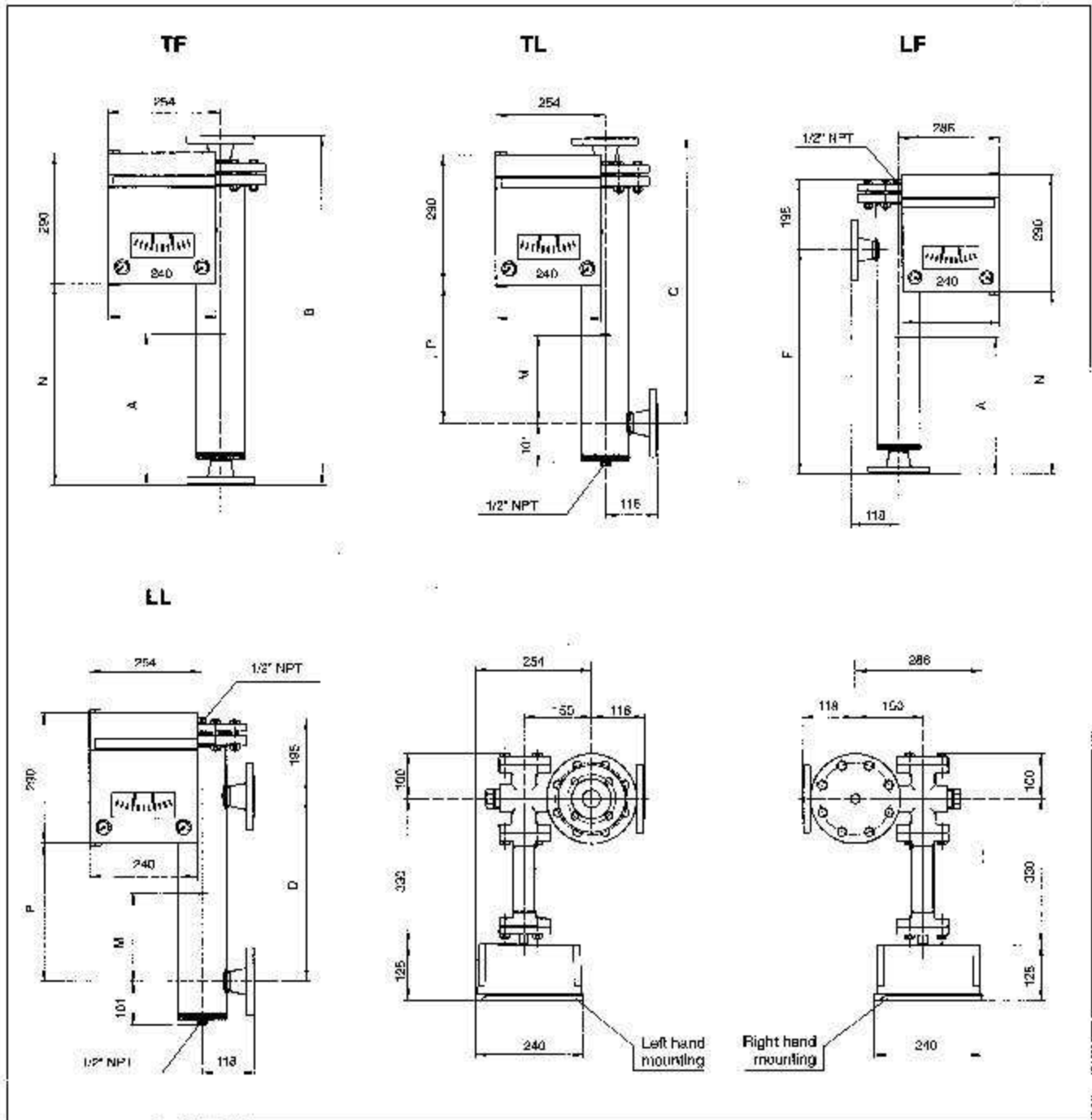

Fig. 6 - Inside view of transmitter-controller case.

GENERAL SPECIFICATIONS

Type of instruments	<ul style="list-style-type: none"> ● indicating pneumatic transmitter with direct measurement of the variable ● indicating pneumatic controller with direct measurement of the variable ● indicating transmitter and controller with direct measurement of the variable 												
Standard ranges of measurement in millimetres (or inches)	<table> <tr> <td>0 – 356 mm (14")</td> <td>0 – 508 mm (20")</td> <td>0 – 610 mm (24")</td> <td>0 – 813 mm (32")</td> </tr> <tr> <td>0 – 1219 mm (48")</td> <td>0 – 1524 mm (60")</td> <td>0 – 1829 mm (72")</td> <td>0 – 2134 mm (84")</td> </tr> <tr> <td>0 – 2439 mm (96")</td> <td>0 – 2743 mm (108")</td> <td>0 – 3048 mm (120")</td> <td></td> </tr> </table>	0 – 356 mm (14")	0 – 508 mm (20")	0 – 610 mm (24")	0 – 813 mm (32")	0 – 1219 mm (48")	0 – 1524 mm (60")	0 – 1829 mm (72")	0 – 2134 mm (84")	0 – 2439 mm (96")	0 – 2743 mm (108")	0 – 3048 mm (120")	
0 – 356 mm (14")	0 – 508 mm (20")	0 – 610 mm (24")	0 – 813 mm (32")										
0 – 1219 mm (48")	0 – 1524 mm (60")	0 – 1829 mm (72")	0 – 2134 mm (84")										
0 – 2439 mm (96")	0 – 2743 mm (108")	0 – 3048 mm (120")											
Specific gravity adjustment ranges	<table> <tr> <td>0.5 to 1.1</td> <td>0.8 to 1.3</td> <td>1.2 to 1.7</td> </tr> </table>	0.5 to 1.1	0.8 to 1.3	1.2 to 1.7									
0.5 to 1.1	0.8 to 1.3	1.2 to 1.7											
Scale	segmental 120 mm long												
Accuracy	1% of range span												
Sensitivity	0.2% of range span												
Repeatability	0.5% of range span												
Linearity	0.5% of range span												
Mode of transmission	direct with proportional action: output signal increases on increasing measured variable												
Action	<ul style="list-style-type: none"> ● direct action: control signal increases on increasing variable ● reverse action: control signal decreases on increasing variable action can be easily selected on the field												
Control modes	<ul style="list-style-type: none"> ● on-off with not adjustable differential gap ● on-off with adjustable differential gap ● proportional (P) with manual reset ● proportional-integral (PI) ● proportional-integral-derivative (PID) 												
Differential	1% of range span (for on-off not adjustable controllers)												
Proportional band	adjustable from 5% up to 200% of the scale span												
Integral action	adjustable from 0.1 to 20 repeats per minute												
Derivative action	adjustable from 0.02 to 20 minutes												
Output signal	0.2 to 1 bar or 3 to 15 psi for modulating control mode or transmission 0-1.4 bar or 0-20 psi for on-off control model												
Set point	<ul style="list-style-type: none"> ● manually adjustable on instruments by knob and index (standard) ● pneumatically adjustable from remote panel through a 0.2 to 1 bar or 3 to 15 psi signal (on request) ● electrically adjustable through a 0 to 10V or 4 to 20 mA or other signal (on request) 												
Air supply	compressed air at 20 psig \pm 1.5 psi (1.4 bar \pm 0.1 bar)												
Air consumption	0.2 Nm ³ /h (average for instruments with single unit)												
Air connections	1/4" NPT female												
Ambient temperature limits	maximum +65°C minimum –15°C												
Case	die cast aluminium, RAL 5010 epoxy coated, spray and dust proof style with standard protection degree IP 54 or 55 on request; connection for internal pressurization (optional)												
Mounting style	with displacer cage for external mounting and location of connections as specified at page 2												
Materials of cage	<ul style="list-style-type: none"> ● carbon steel ● AISI 316 stainless steel 												
Materials of displacer and torque tube	<ul style="list-style-type: none"> ● AISI 316 stainless steel ● Inconel or other special materials 												
Connecting flanges to process	according to UNI 2223-2229 PN 40 or ANSI 300 RF standards; tongues and grooves and flanges special execution upon request												
Maximum pressure for process fluid	standard executions according to PN40 or ANSI 300 lbs rating												
Temperature limits for process fluid	minimum –190°C for stainless steel and –20° for C. steel maximum 400°C for special executions and for stainless steel and 300°C for C. steel.												

MOUNTING STYLE AND DIMENSIONS (mm)*



RANGES		A	B	C	D	F	M	N	P	displacer dia.
Inches	mm									
14"	356	279	733	620	356	469	178	390	267	76
20"	508	355	885	772	508	621	254	532	419	70
24"	610	406	987	874	610	723	305	634	521	60
32"	813	507.5	1190	1077	813	926	406.5	837	724	50
48"	1219	710.5	1596	1483	1219	1332	609.5	1243	1130	40
60"	1524	863	1901	1788	1524	1637	762	1548	1435	36
72"	1829	1015.5	2206	2093	1829	1942	914.5	1853	1740	34
84"	2134	1168	2511	2398	2134	2247	1067	2158	2045	28
96"	2439	1320	2816	2703	2439	2552	1219	2463	2350	28
108"	2743	1472.5	3120	3007	2743	2856	1371.5	2767	2654	28
120"	3048	1625	3425	3312	3048	3161	1524	3072	2959	28

* Dimensions are referred to standard PN40 executions with carbon steel or stainless steel bodies.



Fig. 7 - Instrument for external mounting with side-side connections.