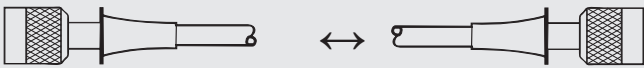
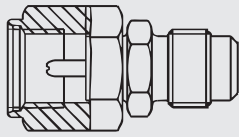

Hydraulic Accessories

Test hose (high pressure)

			Length	Part No.
				
1604	DN4	1604	1 m	6015331
1604	DN4	1604	2 m	6001212
1604	DN4	1620	1 m	6052790
1604	DN4	1620	2 m	349150
1604	DN4	1620	5 m	1251557
1620	DN2	1620	1 m	632634
1620	DN2	1620	1.5 m	682858
1620	DN2	1620	2 m	682859

Adapter

			Part No.
			
1615	↔	1620	629636
female		male	

Low pressure hose (suction/return line hose)

			Length	Part No.	
					
Female coupling	DN7	Male coupling			
	DN7		0.6 m	PVC	1204401
	DN7		1 m	PVC	3300054
	DN7		2 m	PVC	349151
	DN7		5 m	PVC	1251558
	DN7		2 m	PA ¹⁾	349434
	DN7		5 m	PUR	3348206

¹⁾ only for HFD-R fluids

Suction hose

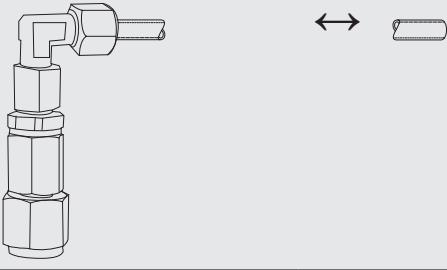
			Length	Part No.
				
1604	DN6	open end	0.3 m	3297276
1604	DN6	open end	0.6 m	3411391
1604	DN6	open end	1.5 m	3325744

			Length	Part No.
				
Female coupling	DN6	Male coupling	0.25 m	3068209
Female coupling	DN6	Male coupling	1.0 m	3036098

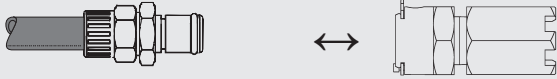
FCU 2000 Suction Strainer (hose not supplied)			Part No.
			
Male coupling	DN6	Female coupling	3487290

Pressure gauge kit

			Part No.
	0 - 40 bar → 1604 / 1620		3491971
	0 - 60 bar → 1604 / 1620		3491973
	0 - 400 bar → 1604 / 1620		3491974

Mounting block for AS1000 / AS3000

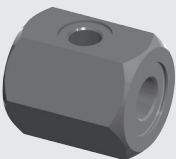
			Part No.
	Mounting block for AS1000 / AS3000	up to max. 50 bar	3182134
	IN: G 1/4"		
	OUT: G 1/4"		

ConditioningModules

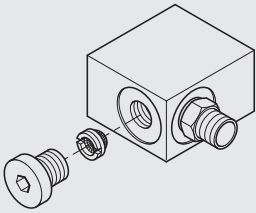
ConditioningModule Strainer [CM-S-1]		Part No.
	Application	Inlet of CSM, CM-RE, CS: protective filter 400 µm
	IN	G ¼ (female thread)
	OUT	G ¼ (male thread; for screwing directly into the inlet of the CM-I)
	Pressure range	Up to 120 bar
	Setting range	not adjustable
	Items supplied	CM-S-1
		3860591

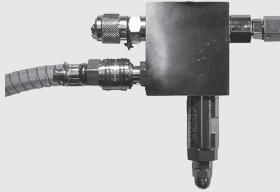
ConditioningModule Inlet [CM-I]		Part No.
	Application	Inlet of CS: SRE1 valve reduces the flow from the main system to approx. 600 ml/min and the pressure fluctuations across the inlet of the CS are stabilized by opening the return line via the adjustable pressure relief valve
	IN	Minimess test connection 1604 (in port G ¼)
	OUT	Threaded connection with male thread G ¼ for screwing directly into the inlet of the CS Return line: DN7 male connection (in port G ¼)
	Pressure range	Up to 350 bar
	Setting range	0 ... 30 bar (DB4E)
	Permitted viscosity range	1 ... 1000 mm ² /s
	Connection	G ¼ for pressure gauge
	Items supplied	CM-I, return line 2 m
		3226048

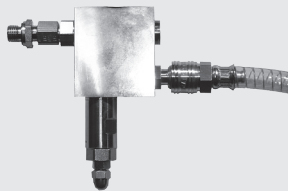
ConditioningModule Outlet [CM-O]		Part No.
	Application	Outlet of CS: suppresses air bubbles by pressurizing the test line and limits the flow when the CS is operated in bypass mode or with a separate pump (CM-RE)
	IN	Threaded connection with male thread G ¼ for screwing directly into the outlet of the CS
	OUT	DN7 male connection (in port G ¼)
	Pressure range	Up to 350 bar
	Setting range	0 ... 30 bar (DB4E) Recommendation: 5 ... 10 bar (for hydraulic oils) 20 ... 25 bar (for lubrication oils)
	Permitted viscosity range	1 ... 1000 mm ² /s
	Connection	G ¼ for pressure gauge
	Items supplied	CM-O, return line 2 m
		3226051

ConditioningModules

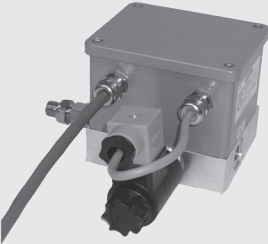
ConditioningModule Flow Control [CM-FC]		Part No.
	Application	Outlet of CS 2000: proportional control of the flow using separate flow rate sensor which is not sensitive to contamination
	IN	Threaded connection with male thread G ¼ for screwing directly into the outlet of the CS
	OUT	G ¼ connection (female thread)
	Pressure range	Up to 40 bar
	Setting range	not adjustable
	Permitted viscosity range	10 ... 1000 mm ² /s
	Note	Only available when ordering a CS 2xxx-1-U/-4-1 or /-6 and /-7. When using the CM-FC the analogue output / 4 ... 20 mA is no longer available.
	Items supplied	CM-FC, connection cable
		3226053

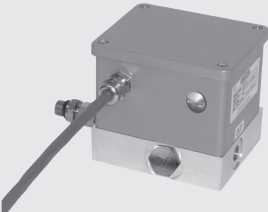
ConditioningModule Fluid Sensor [CM-FS]		Part No.
	Application	Outlet of CS 2000: separate flow meter
	IN	Threaded connection with male thread G ¼ for screwing directly into the outlet of the CS
	OUT	G ¼ connection (female thread)
	Pressure range	Up to 40 bar
	Setting range	not adjustable
	Permitted viscosity range	10 ... 1000 mm ² /s
	Note	Available only when ordering a CS 2xxx.
Items supplied	CM-FS, connection cable	
		3264341

ConditionModule Reservoir Extraction CM-RE

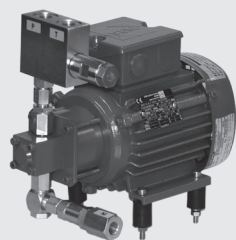

The ConditioningModule Reservoir Extraction CM-RE is designed as an accessory to the CS ContaminationSensors and the FCU FluidControl Units. The CM-RE is a self-priming motor-pump unit which makes it possible for the CS/FCU to measure oil cleanliness in unpressurised reservoirs, tanks or leakage lines.

The oil being analyzed is drawn through the suction strainer at the inlet port (IN). The gear pump supplies the oil at a maximum pressure of 60 bar (870 psi) to the pressure port (P) so that it can be analyzed by the CS / FCU

The pressure relief valve relieves any positive pressure via connection (T) as leakage oil.

For modules with a pump with increased inlet pressure (CM-RE-2 ...), internal leakage oil is drained from the pump via the separate LEAKAGE connection.

Reservoir Extraction Unit REU

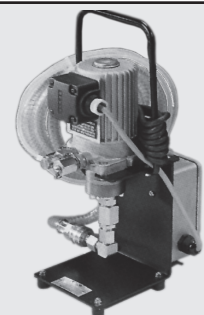

The Reservoir Extraction Unit REU is supplied as an accessory to the FluidControl Units. The REU is a self-priming motor-pump unit which makes it possible for the FCU to measure oil cleanliness even in depressurised reservoirs, tanks or leakage oil lines.

The oil being analyzed is drawn through the suction strainer at the inlet port (IN). The gear pump supplies the oil at a maximum pressure of 20 bar (290 psi) to the pressure port (P) so that it can be analyzed by the FCU

The pressure relief valve relieves any positive pressure via connection (R) as leakage oil.

SmallFiltration Kit SFK

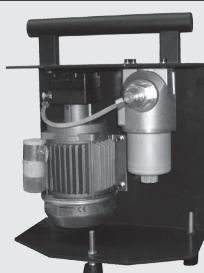

The SmallFiltration Kit SFK is a small filtration unit complete with motor-pump unit for filtering mineral oil-based fluids.

With a flow rate of 0.4 l/min and a inline filter type LF60, the SFK is designed for use in conjunction with particle counters in laboratories and workshops.

Mineral oils used as rinsing fluids for particle counters such as the ALPC or the FCU from HYDAC can be cleaned using the SFK.

Connection Examples Hydraulic Accessories

FluidMonitoring Modules for CS1000

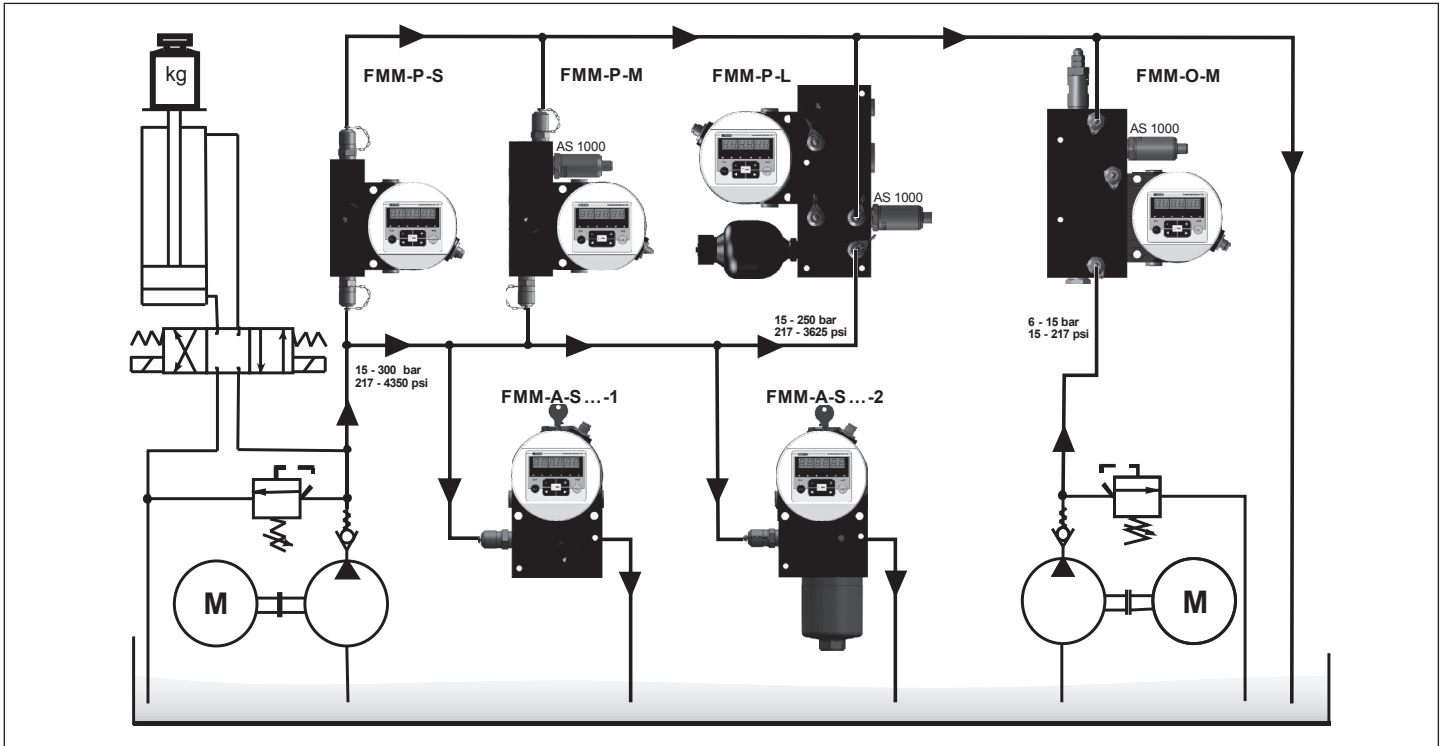



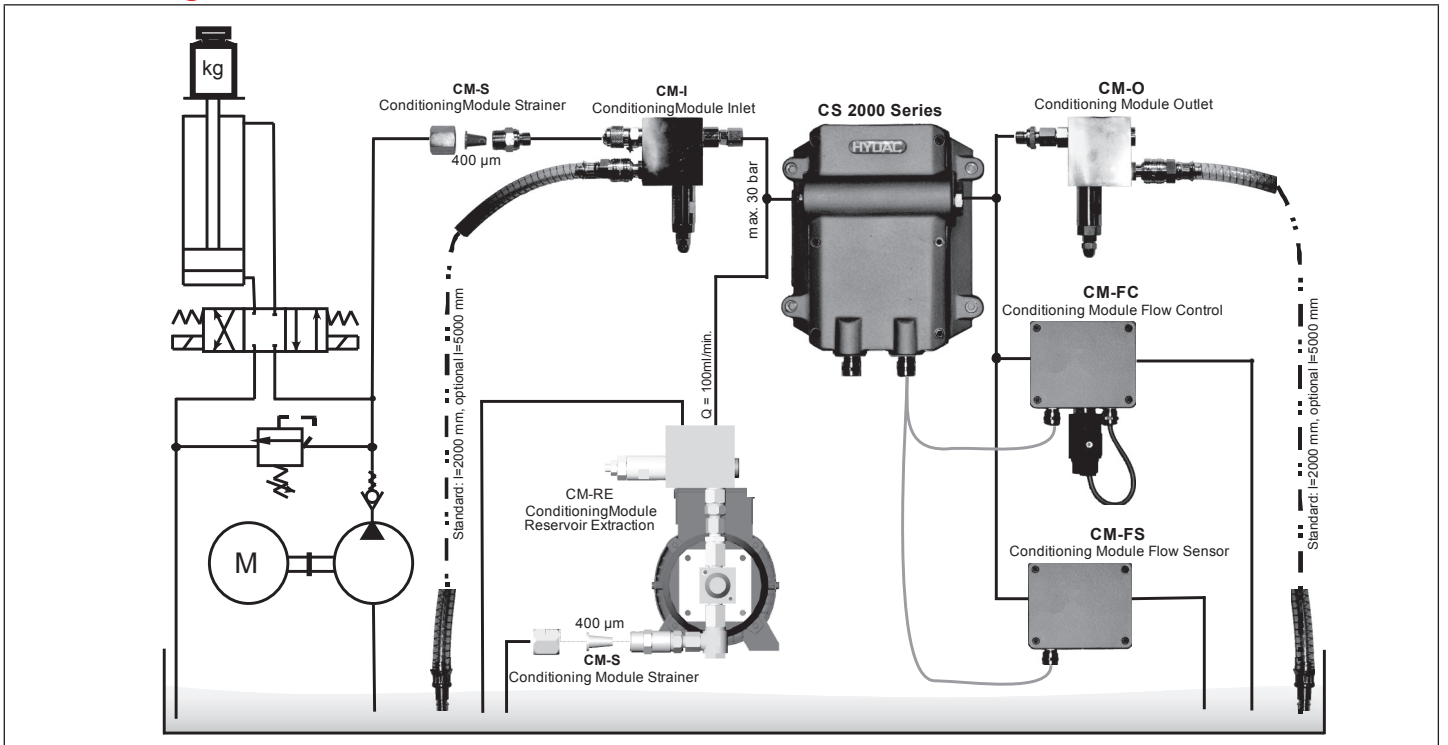

Conditioning Modules for CS2000





















Electrical Accessories

Connector, female

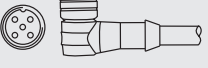
			Part No.
5 	Female connector with screw terminal, 5-pole, M12x1, to DIN VDE 0627	-	6049128
5 	Female connector with screw terminal, with shielding, 5-pole, M12x1, to DIN VDE 0627	ZBE 08	6006786
8 	Female connector with screw terminal, 8-pole, M12x1, to DIN VDE 0627	ZBE 44	3281243
8 	Female connector with screw terminal, 8-pole, M12x1, to DIN VDE 0627	ZBE 0P	6055444

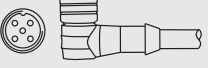
Connection cable, with shielding

Connector, female	↔	Cable with open end	Length	Part No.
8 	↔	 8 + shielding	2 m ZBE42S-02	3281220
8 	↔	 8 + shielding	5 m ZBE42S-10	3281239
8 	↔	 8 + shielding	10 m ZBE42S-10	3449681
5 	↔	 5 + shielding	5 m ZBE47S-05	3527626
5 	↔	 5 + shielding	10 m ZBE47S-10	3527627
5 	↔	 5 + shielding	2 m ZBE08S-02	6019455
5 	↔	 5 + shielding	5 m ZBE08S-05	6019456
5 	↔	 5 + shielding	10 m ZBE08S-10	6023102
5 	↔	 5 + shielding	30 m ZBE08S-30	6035063

Connection cable, with shielding

Connector, male	↔	Cable with open end	Length	Part No.
	↔	8 + shielding	2 m ZBE48S-02	6072261
	↔	8 + shielding	5 m ZBE48S-05	6070712
	↔	8 + shielding	10 m ZBE48S-10	6072262

Connection cable

Connector, female	↔	Cable with open end	Length	Part No.
	↔	8	2 m ZBE 0P-02	6052697
	↔	5	2 m ZBE 08-02	6006792
	↔	5	5 m ZBE 08-05	6006791
	↔	5	5 m ZBE 47-05	3484562
	↔	5	10 m ZBE 47-10	3484564









Cable coding

<ul style="list-style-type: none"> 1 white 2 brown 3 green 4 yellow 5 grey 6 pink 7 blue 8 red shielding 	ZBE 42S ZBE 48S	<ul style="list-style-type: none"> 1 brown 2 white 3 blue 4 black 5 grey 	ZBE 08 ZBE 47
		<ul style="list-style-type: none"> 1 brown 2 white 3 blue 4 black 5 grey shielding 	ZBE 08S ZBE 47S

Connection / extension cable

Connector, female	↔	Connector, male	Length	Part No.
	↔	8	5 m ZBE 43-05	3281240
	↔	8	10 m ZBE 43-10	3519768
	↔	5	2 m ZBE 30-02	6040851
	↔	5	3 m ZBE 30-03	6053924
	↔	5	5 m ZBE 30-05	6040852
	↔	5 + shielding	10 m ZBE 30S-10	3729098



Connection cable – ETHERNET

Ethernet (industrial)	↔ RJ45	Length	Part No.
4* 	↔  RJ45 Patch	5 m ZBE 45-05	3346100
4* 	↔  RJ45 Patch	10 m ZBE 45-10	3346101
4* 	↔  RJ45 Cross	5 m ZBE 46-05	3346102
4* 	↔  RJ45 Cross	10 m ZBE 46-10	3346103

* For ETHERNET only (coding "D": IEC 61076-2-101)

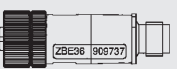

Adapter

For: AS 1000 / HYDACLab ↔ HMG

			Part No.
Connector, female	5   	Connector, male	ZBE 36 909737

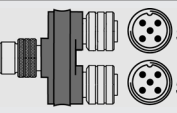

Y-Adapters

For: AS 1000 / HYDACLab ↔ HMG

			Part No.
Connector, female	5    	Connector, male Connector, male	ZBE 26 3304374

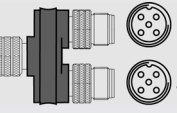

Colour: blue

For: HMG 500 / HMG 3000
to double the number of input sockets

			Part No.
Connector, male	5    	Connector, female Connector, female	ZBE 38 3224436

Colour: black

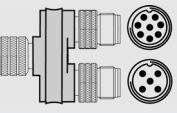
For: CS 1000 ↔ CSI / HMG







			Part No.
Connector, female	8    	Connector, male Connector, male	ZBE 41 910000

Colour: yellow

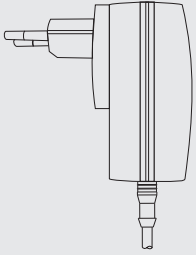

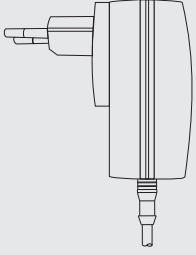
Dust cap

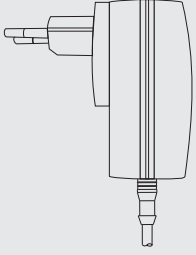
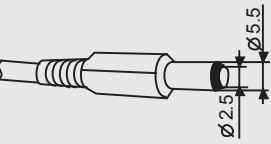
			Part No.
	Cover for M12 connections (nickel-plated)		6079195

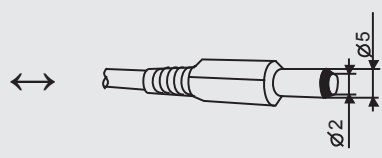

Power supply



Power supply	↔ Connector, female	Length	Part No.
100 – 240 V AC, 50-60 Hz  Protection class: IP40 Example: CS 1000	15 V DC, 800 mA ↔  8	1.8 m PS1	3376530
100 – 240 V AC, 50-60 Hz  Protection class: IP40 Example: SMU 1000 series	24 V DC, 1000 mA ↔  5	1.8 m PS5	3399939
100 – 240 V AC, 50-60 Hz  Protection class: IP40 Example: FAS / CSI-D-5	12 V DC, 2000 mA ↔ 	1.8 m PS7	6099121
100 – 240 V AC, 50-60 Hz  Without power cable Protection class: IP40 Example: FCU 1000 / ROCS 1000	24 V DC, 5000 mA ↔ 	1.8 m PS3	6059933

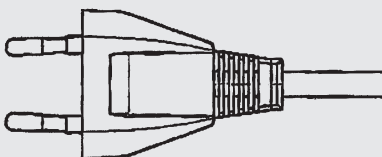

100 – 240 V AC, 50-60 Hz	24 V DC, 2200 mA					
		1.8 m	PS4			3090803
Without power cable Protection class: IP40 Example: FCU 2000-x						

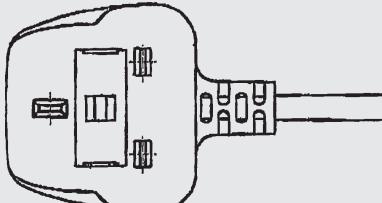

90 – 240 V AC, 47-63 Hz	12 V DC, 6600 mA					
		1.6 m	PS6			6066586
Without power cable Protection class: IP40 Example: FCU 1000, Field Verification Kit						

Connecting cable for power supply (PS3 / PS4)

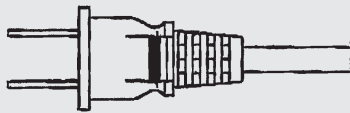

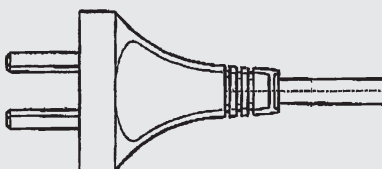

Connector, male	↔	Connector, female	Length	Part No.
	↔		2 m –	6008448
Europe – EN50075				

	↔		2 m –	6008447
United Kingdom				

	↔		2 m –	6008446
USA				

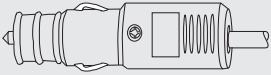
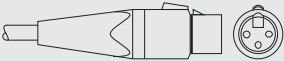
	↔		2 m –	6008449
Australia – A.S. 3112				

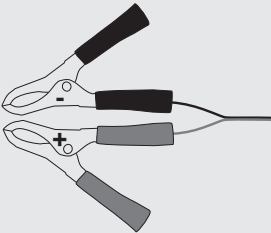
Power supply cable

Connector, male	↔ Connector, female	Length	Part No.
max. 24 V DC  Example: FCU 1000	↔ 	10 m –	3306236
max. 24 V DC  Example: FCU 1000	↔ 	1 m –	3524138
Battery clamps	↔ Connector, female	Length	Part No.
max. 24 V DC  Example: FCU 1000	↔ 24 V DC 	0.35 m –	6051653

Connection cable, parallel

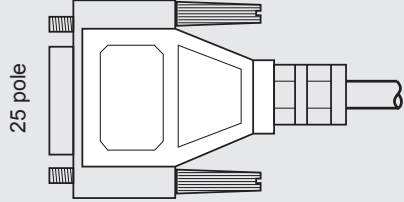
Connector, male	↔ Connector, female	Length	Part No.
 25 pole Example: FCU 2000 -> external printer	↔ CENTRONICS interface	3 m –	349157

Connection cable - serial

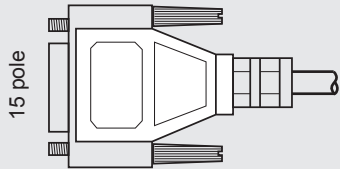
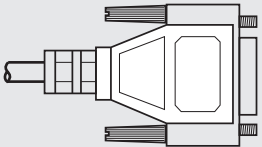
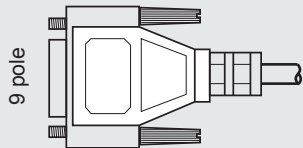
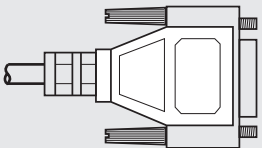
Connector, female	↔ Connector, female	Length	Part No.
 15 pole Example: FCU 2000 -> PC	↔  9 pole	2 m –	349204
Connector, female	↔ Connector, male	Length	Part No.
 9 pole Example: ConditionSensor interface <-> Adapter / PC (RS232 cable)	↔  9 pole	1.8 m –	629269

Connection cable - USB

Connector, female	↔	Connector, female	Length	Part No.
A		B	1.8 m -	6064126
A		B	5 m -	6064127

Bluetooth adapter

	↔	Part No.
Bluetooth	USB (A)	6074886

Converter

Connector, female	↔	Terminal strip	Part No.
RS 232		RS 485	6013281
USB (B)		RS 485	6042337

Connector, female	↔	Connector, male	Part No.
USB (A)		RS 232	6048267

CSI-B-1

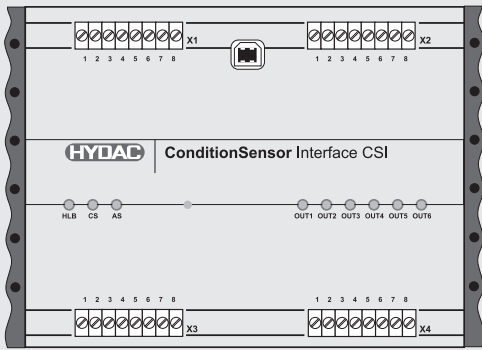

3308212

Protection class: IP40

CSI-B-2 Kit

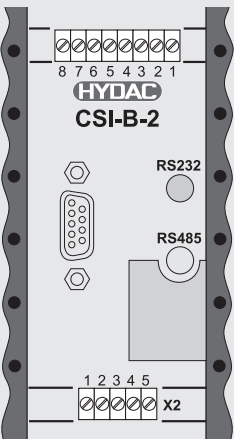

consisting of:

- CSI-B-2
- 3 x connection cable ZBE08S-05
- Connection cable ZBE42S-05
- RS232 cable
- Y-Adapter ZBE41
- Converter RS232/USB
- FluMoS Light CD

3409462

Protection class: IP40

CSI-B-7

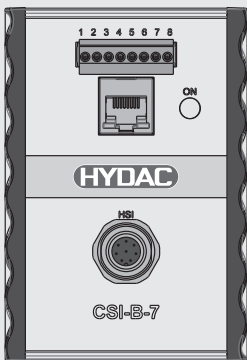

3713134

Protection class: IP40

CSI-D-5 KIT

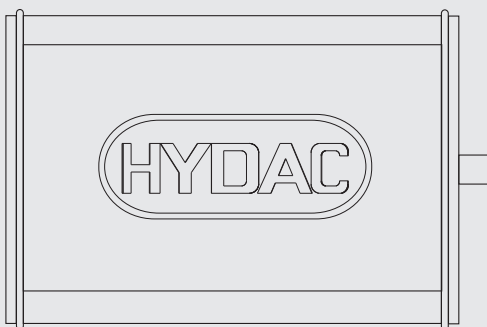

consisting of:

- CSI-D-5
- Power supply PS7
- USB cable, L=1.8m
- Connection cable ZBE43-05
- FluMoS Light CD

3249563

Protection class CSI-D-5: IP40

Connection Examples Electrical Accessories

FCU1000 - Bluetooth / SMU12x1 - Bluetooth

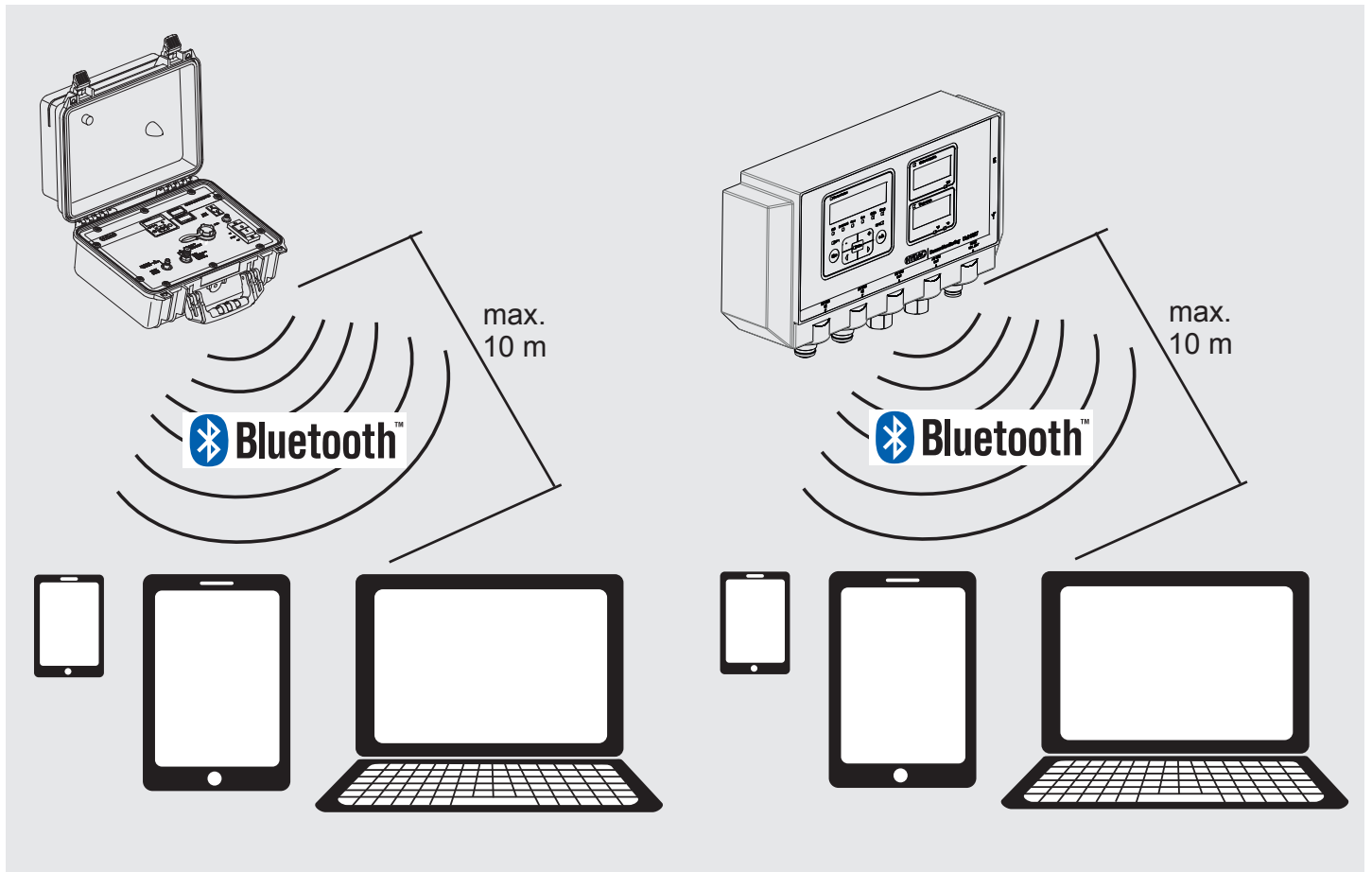

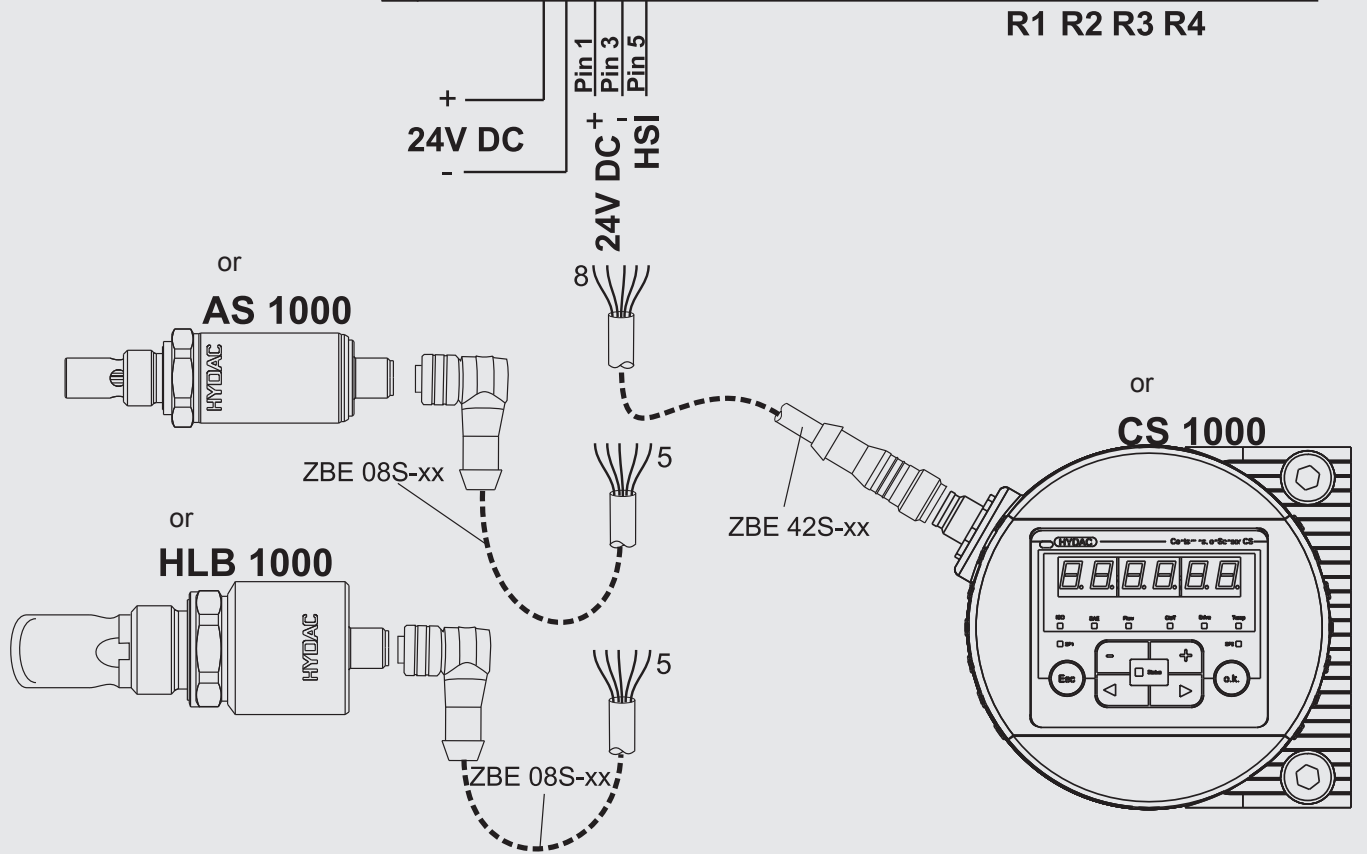
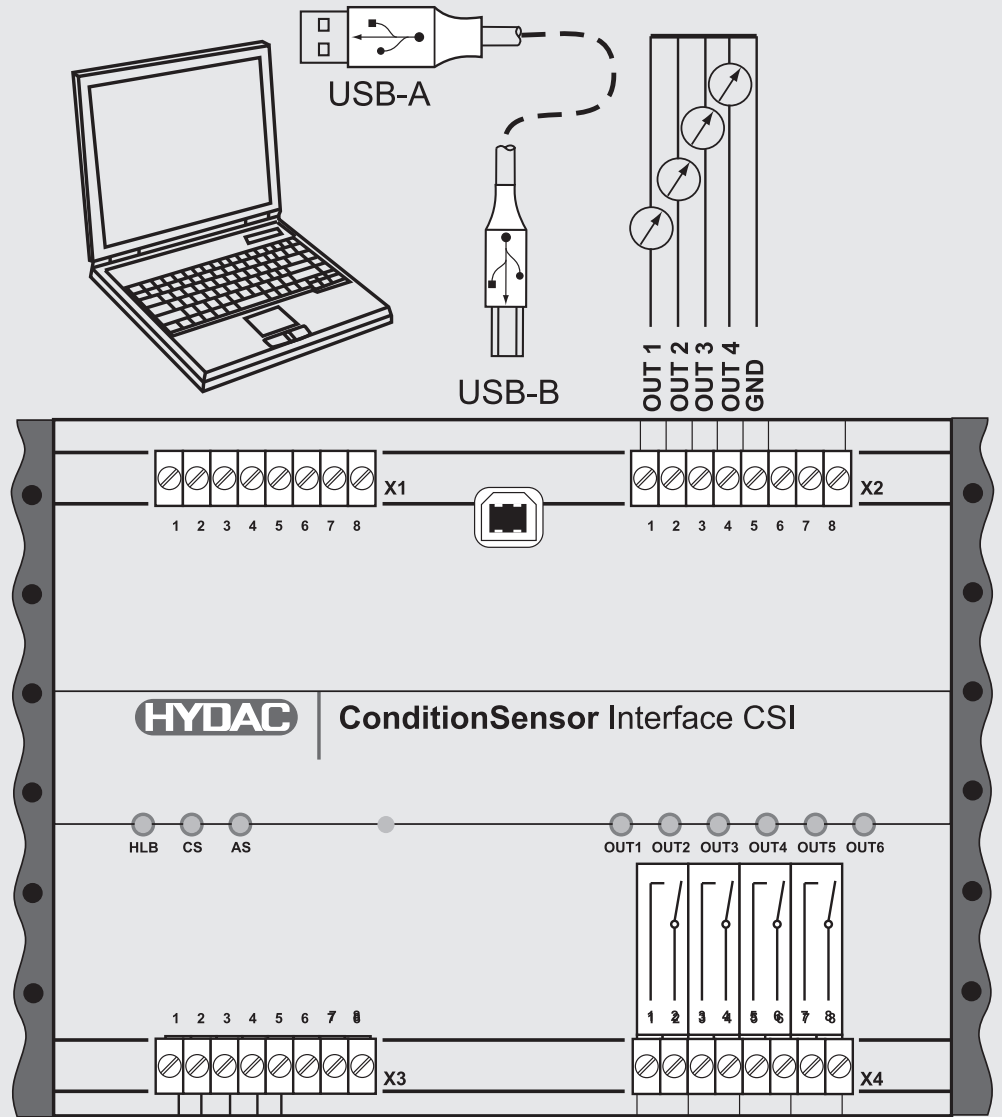

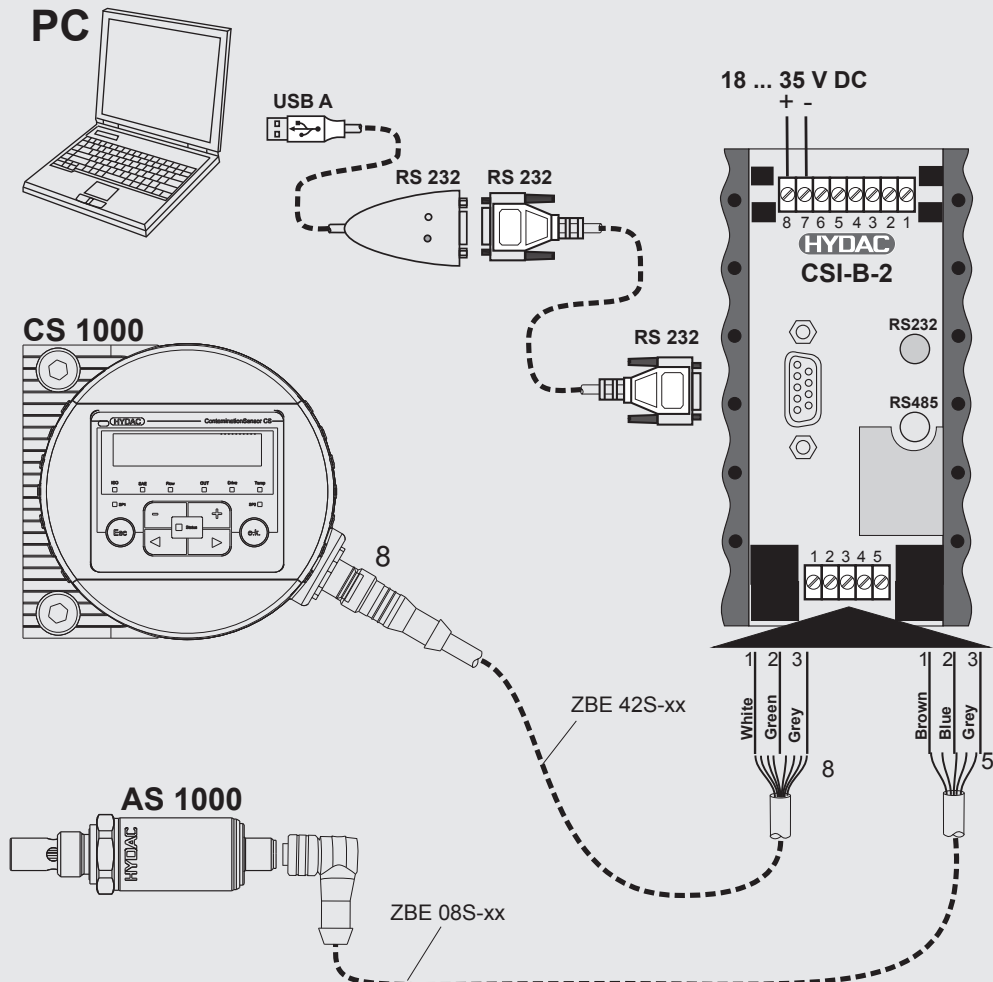
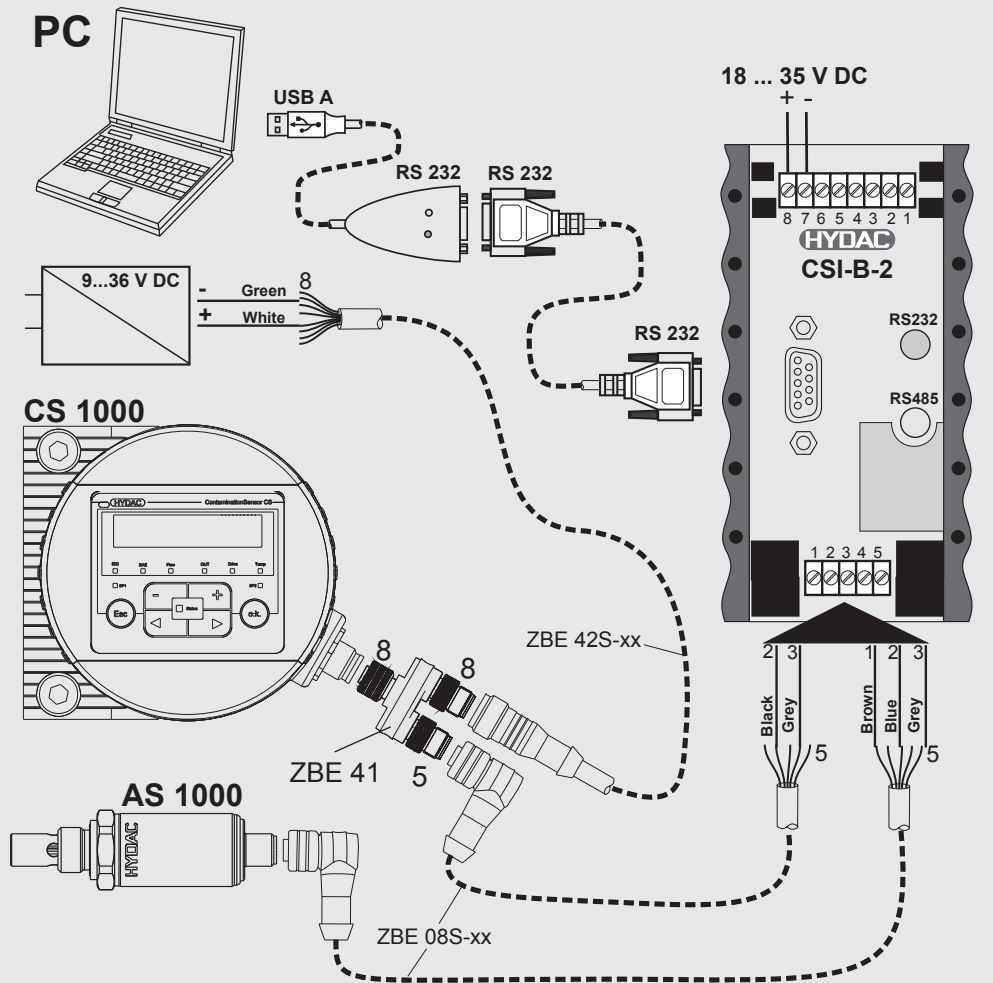

CSI-B-2 - CS1000 / AS1000 / FCU1000 with RS232

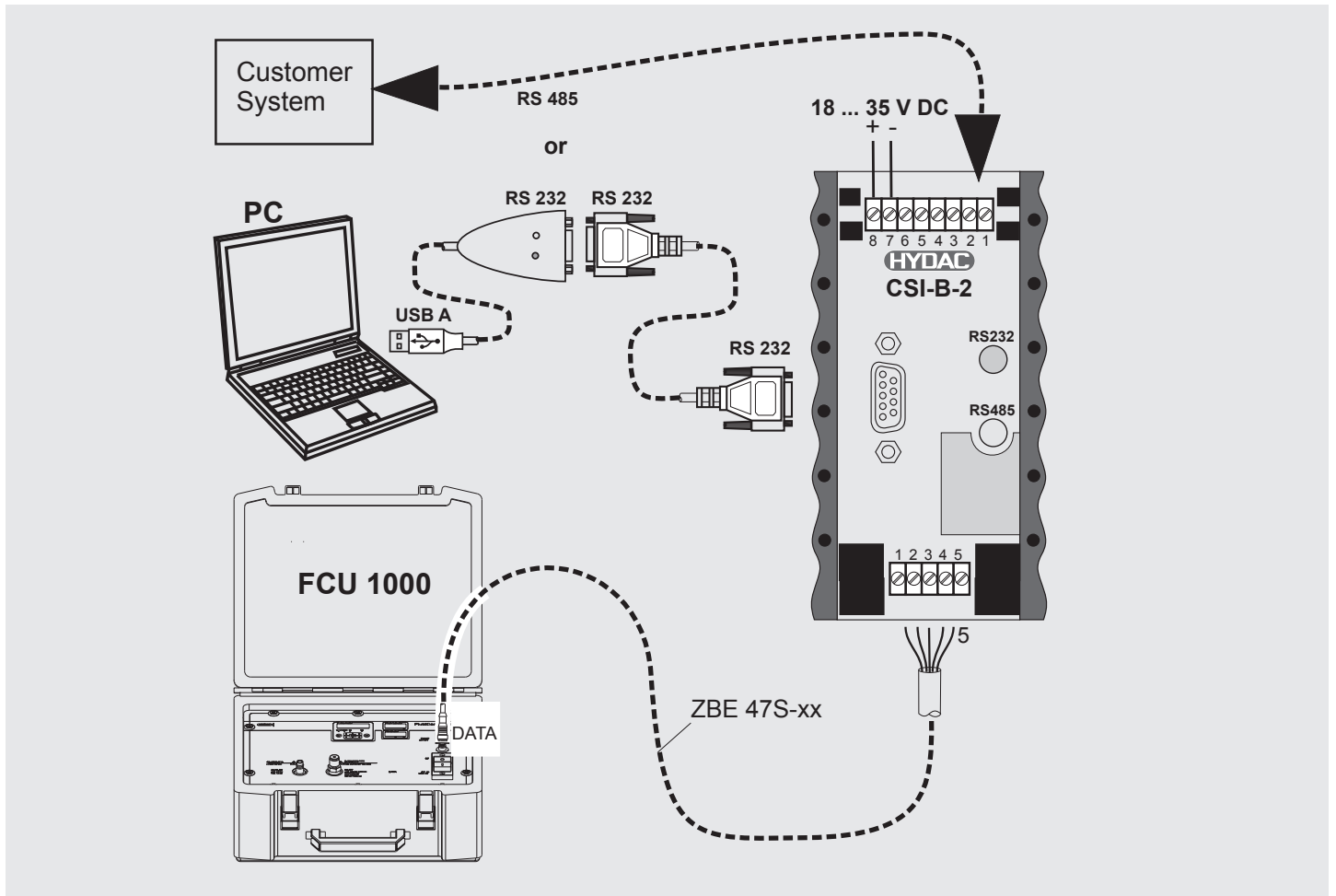

CSI-D-5 Kit - CS1000

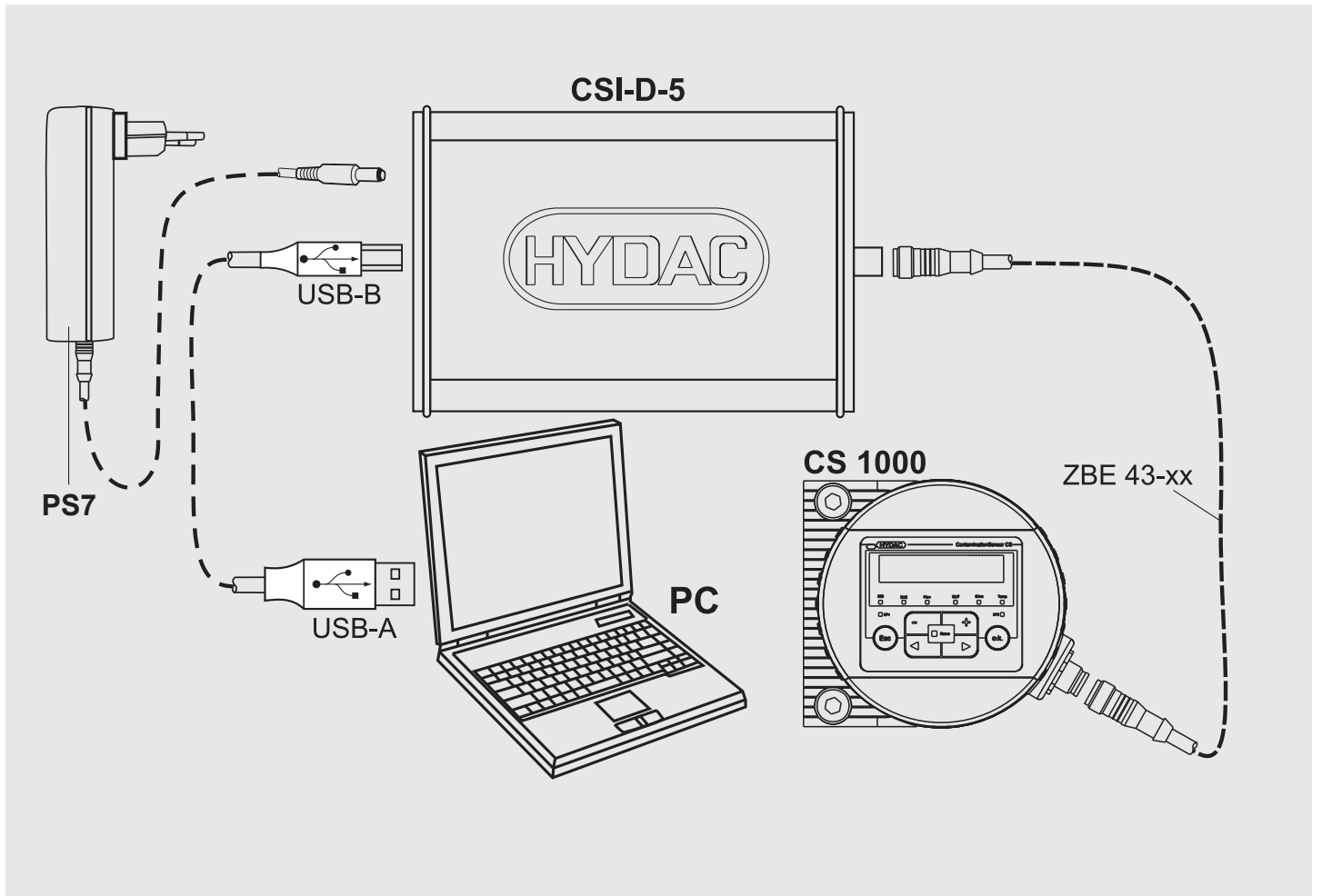

CSI-D-5 Kit - MCS1000

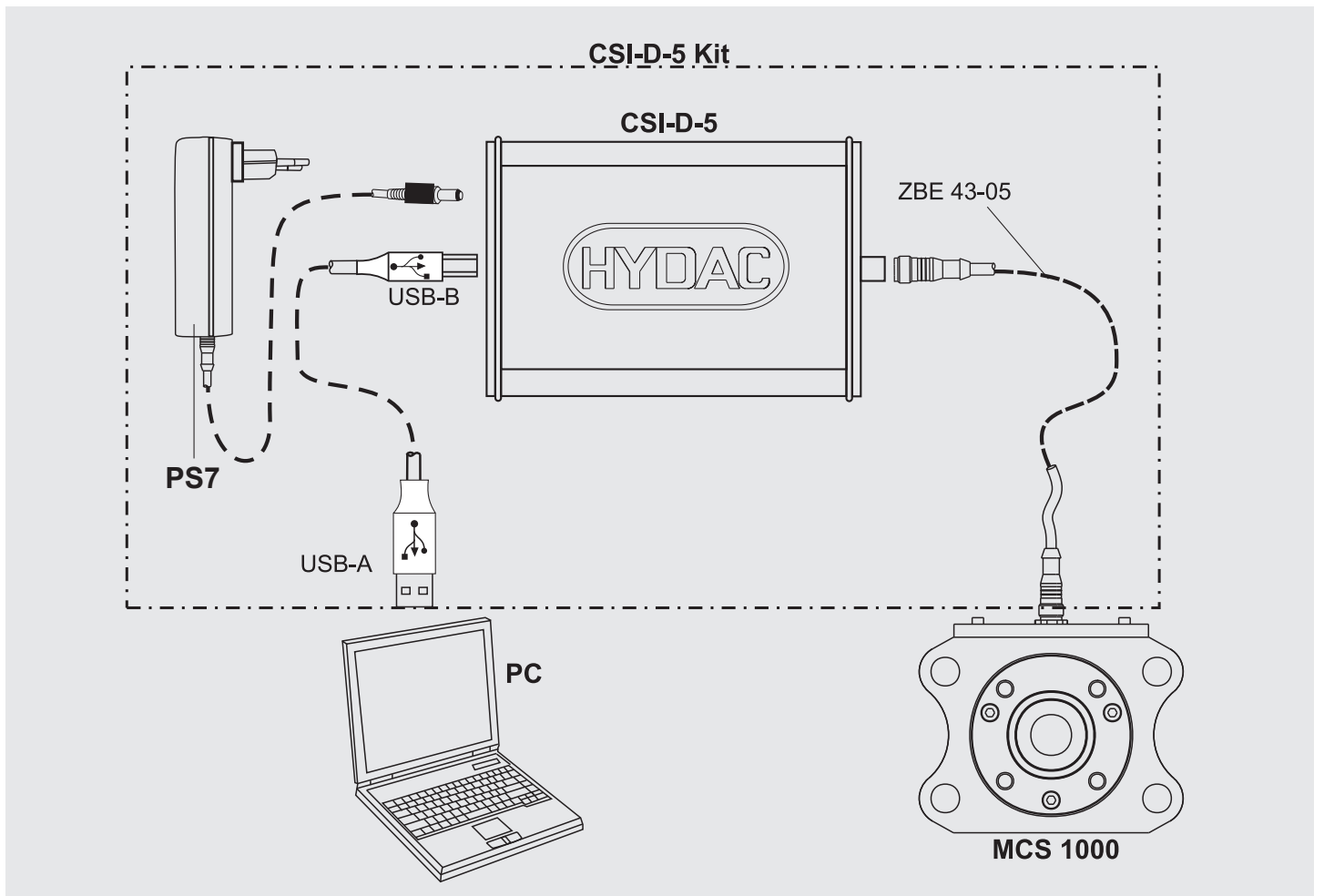

CS1000 in the RS485 BUS

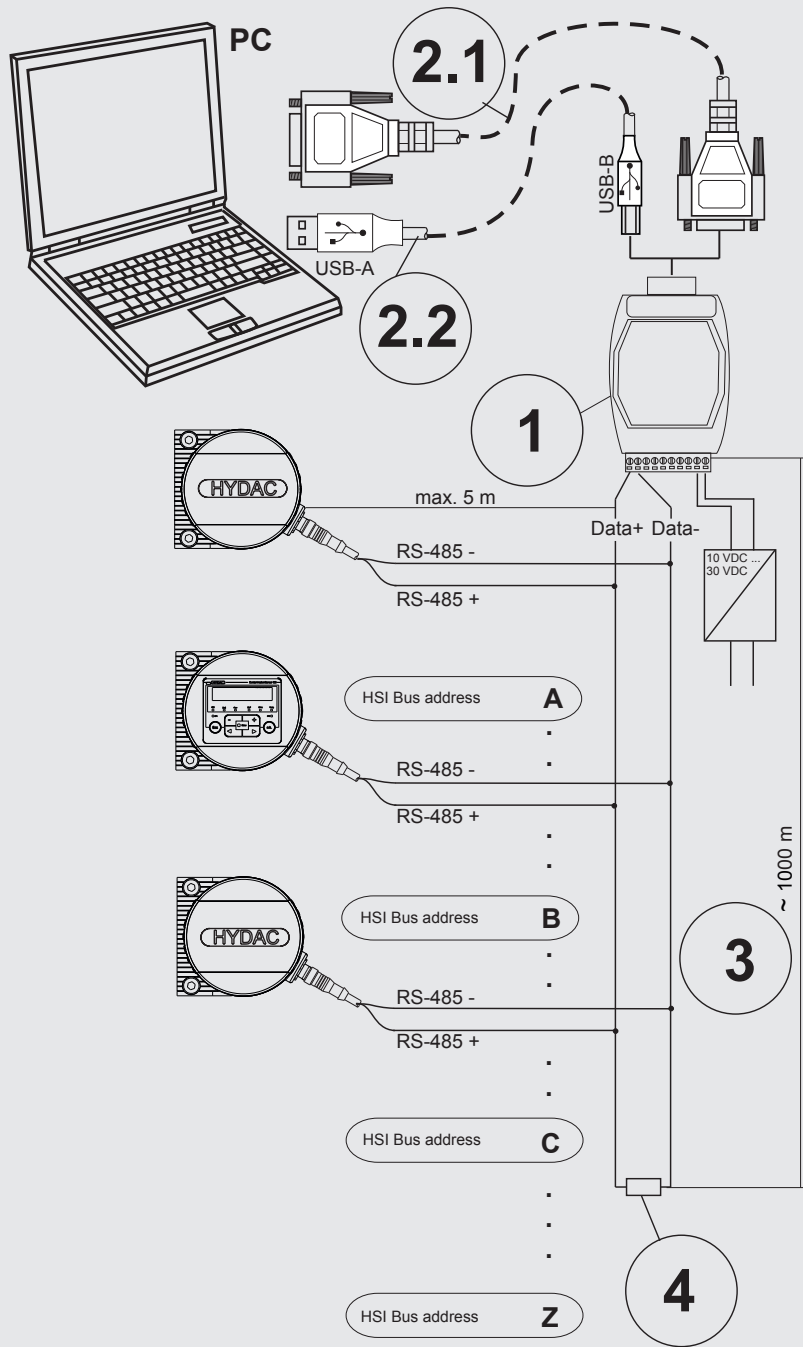

Item	Description	
1	Converter	RS232 <--> RS485
1	Converter	USB <--> RS485
2.1	Connection cable	RS232, 9-pole
2.2	Connection cable	USB [A] <--> USB [B]
3	Cable	Twisted pair recommended
4	Terminating resistor	≈ 120 Ω

MCS1000 in the RS485 BUS

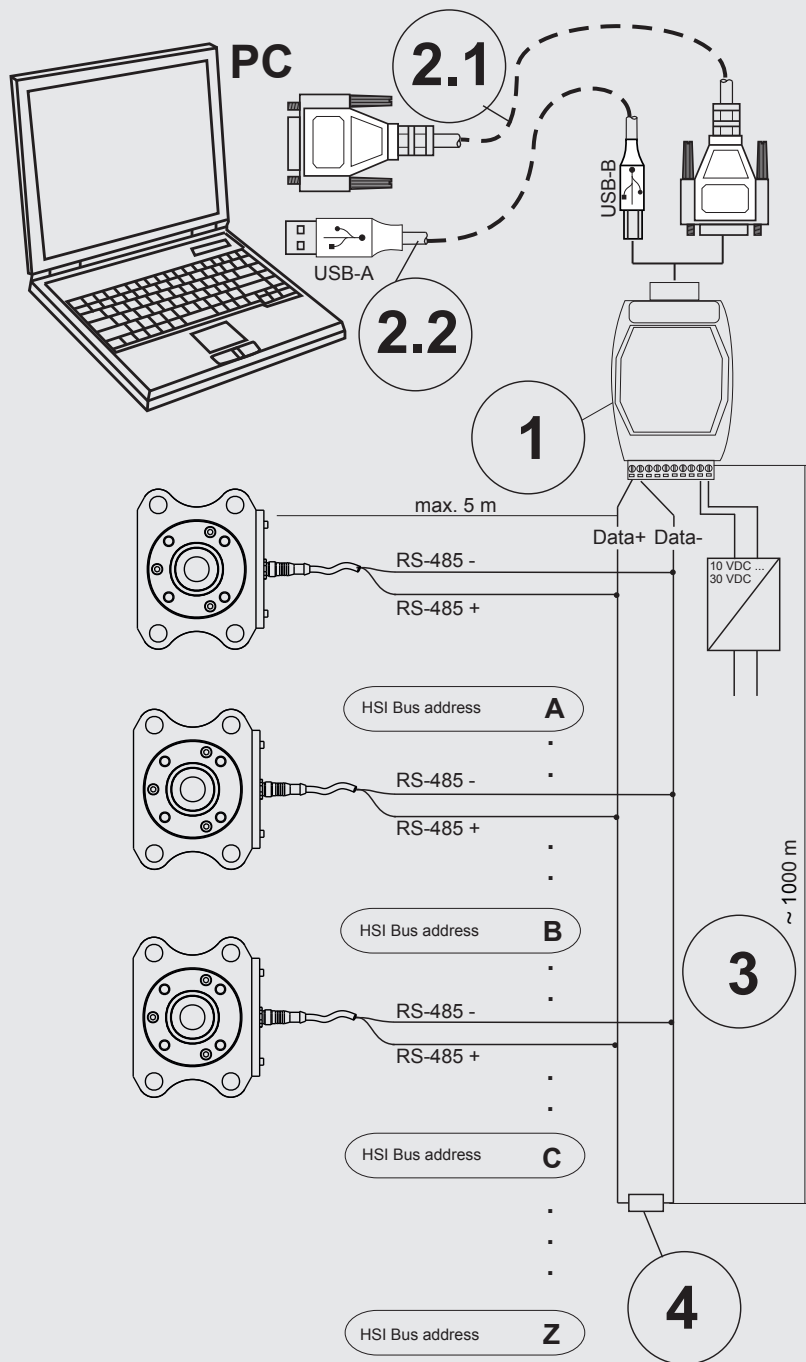

Item	Description	
1	Converter	RS232 <--> RS485
1	Converter	USB <--> RS485
2.1	Connection cable	RS232, 9-pole
2.2	Connection cable	USB [A] <--> USB [B]
3	Cable	Twisted pair recommended
4	Terminating resistor	$\approx 120 \Omega$

AS 1000

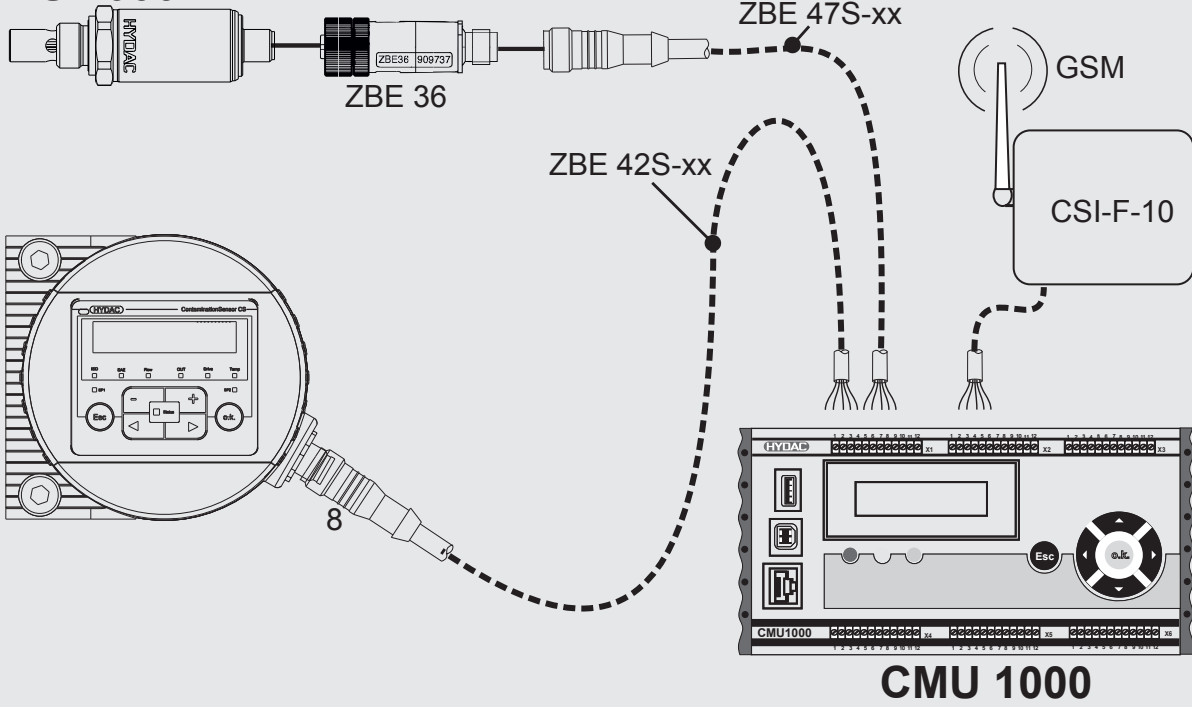

HMG3000 / HMG500 - CS1000 / AS1000

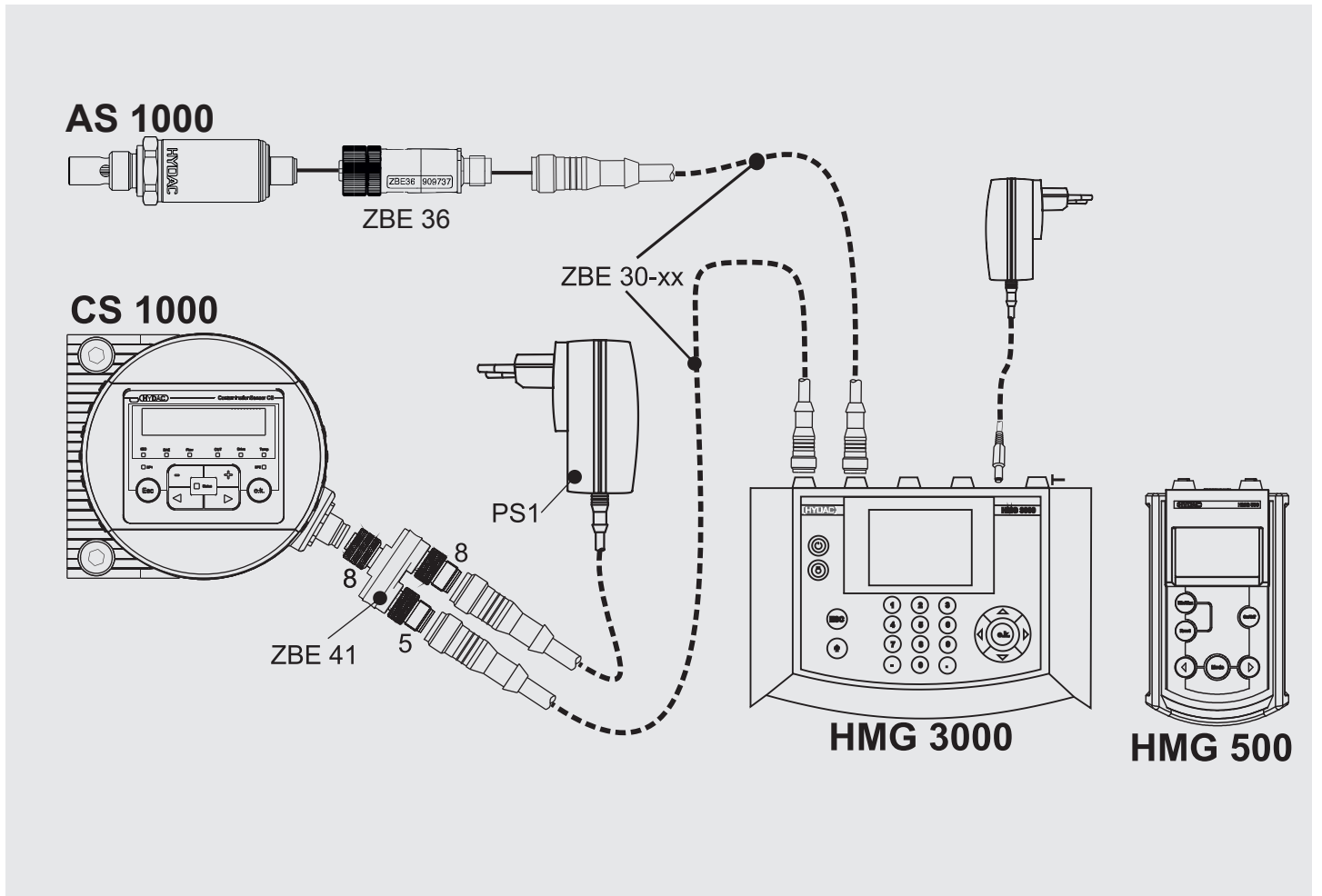

HMG3000 / HMG500 - FCU1000

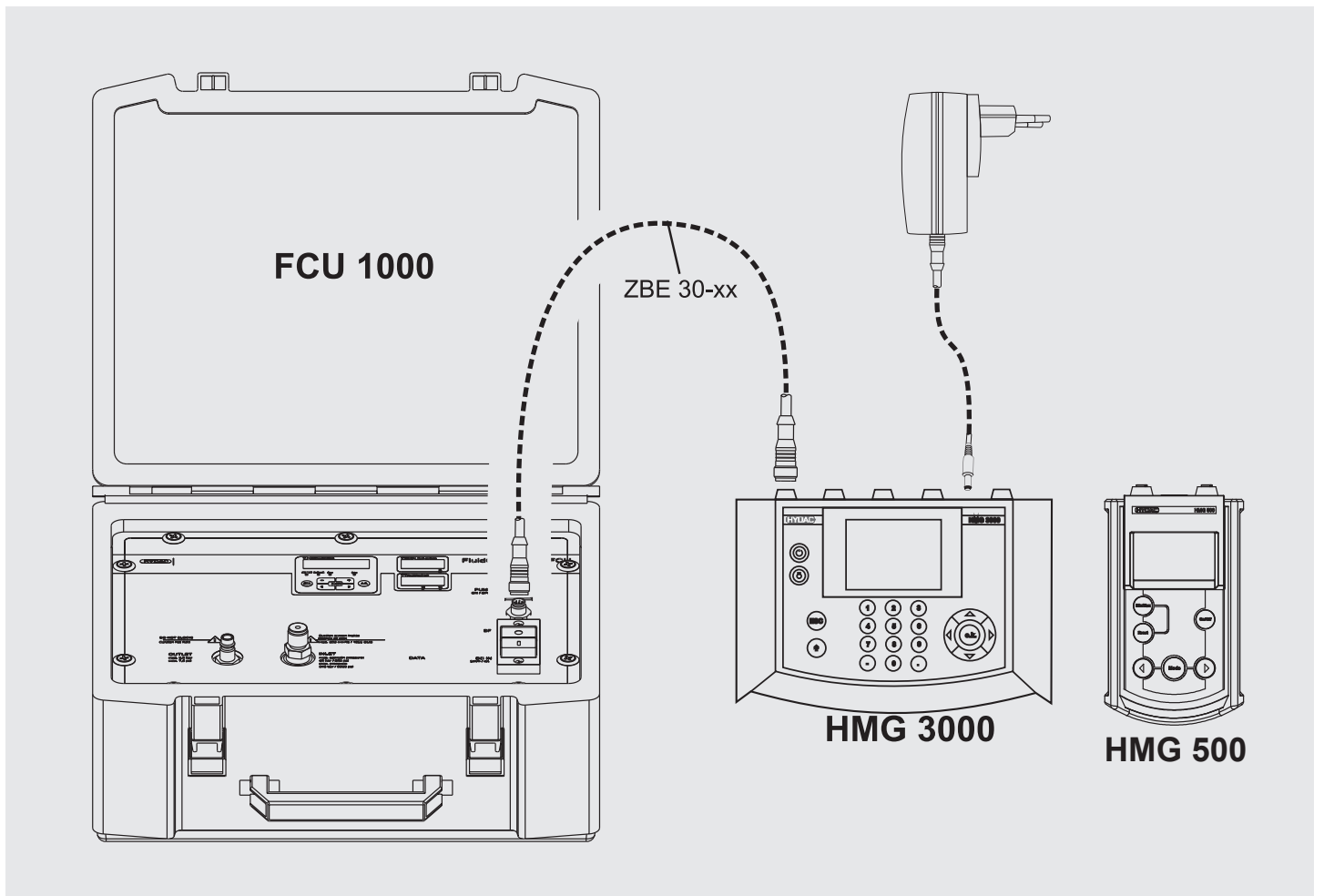

HMG3000 - MCS1000

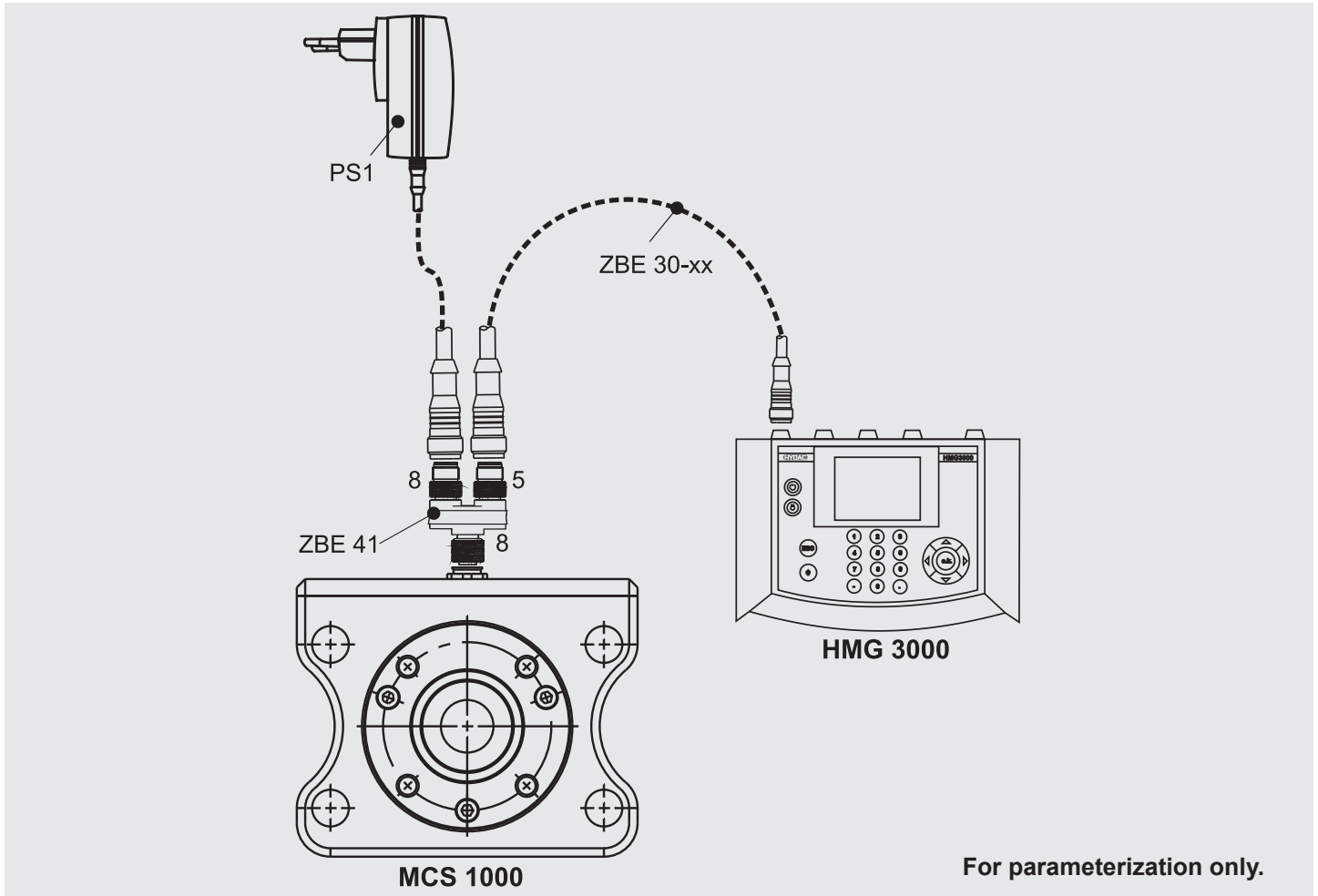

SMU1260 / CSI-B-2 / HMG3000 - MCS1000

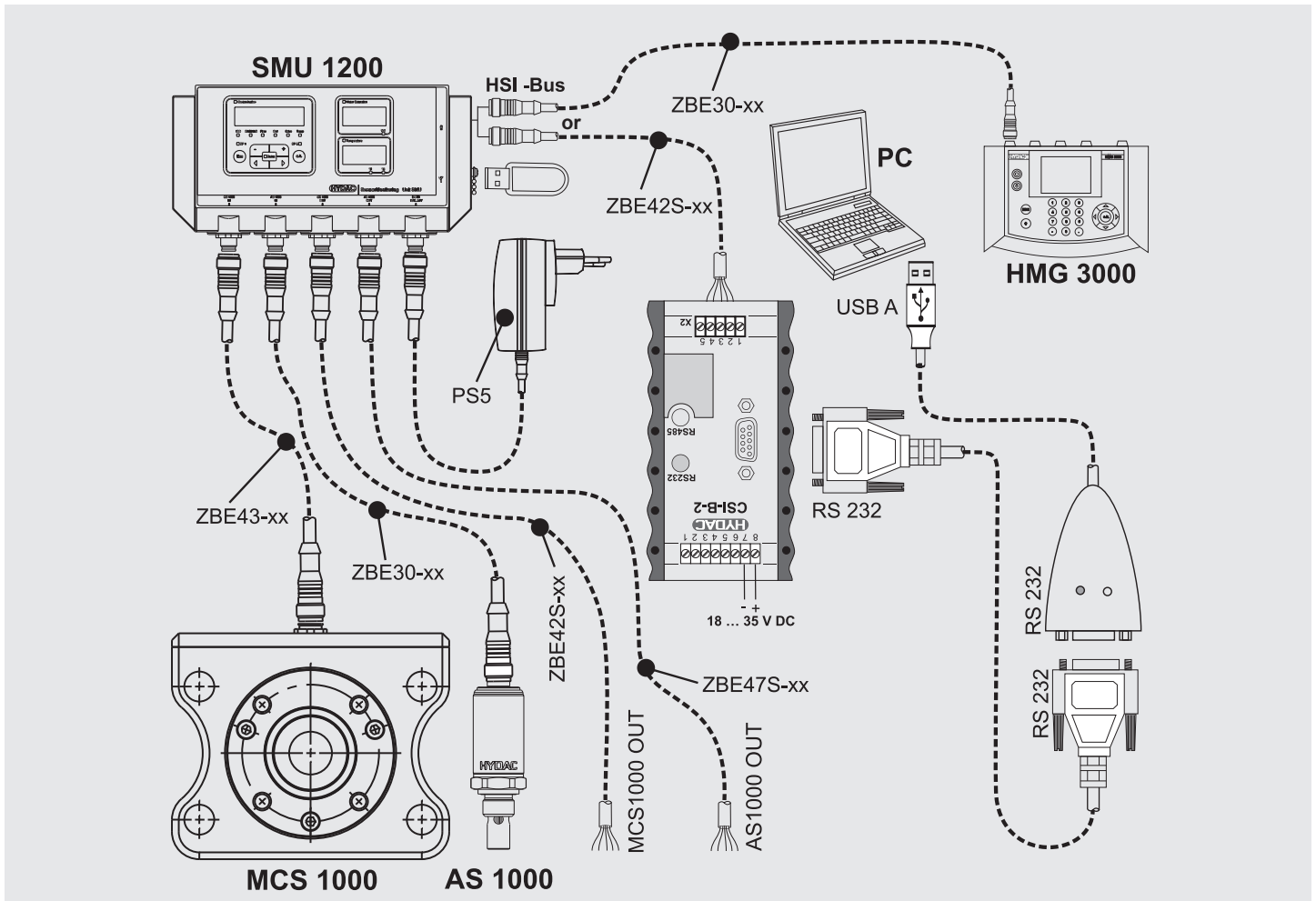

SMU1260 / CSI-B-2 / HMG3000 - CS1000

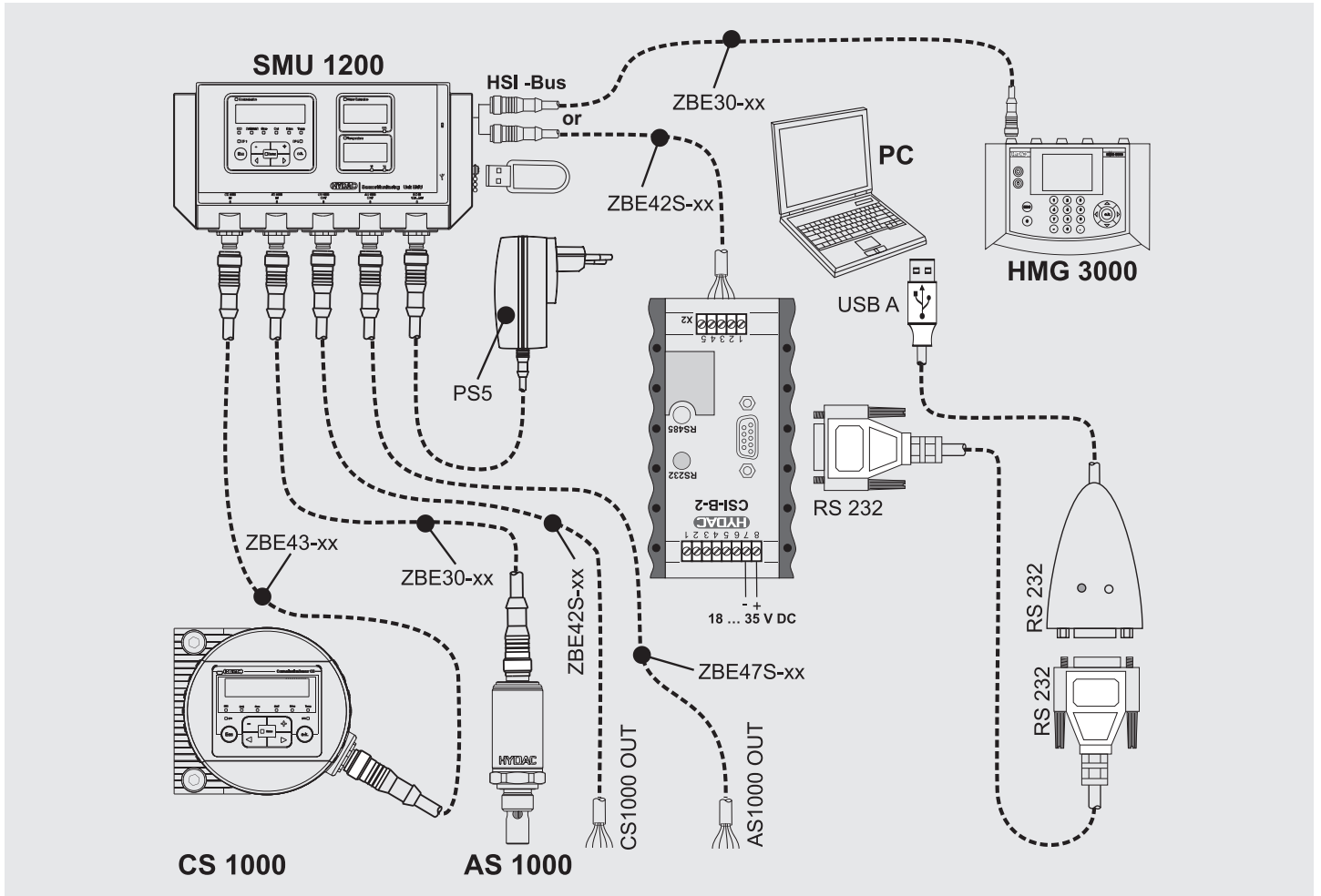

SMU1270 / LAN / PC

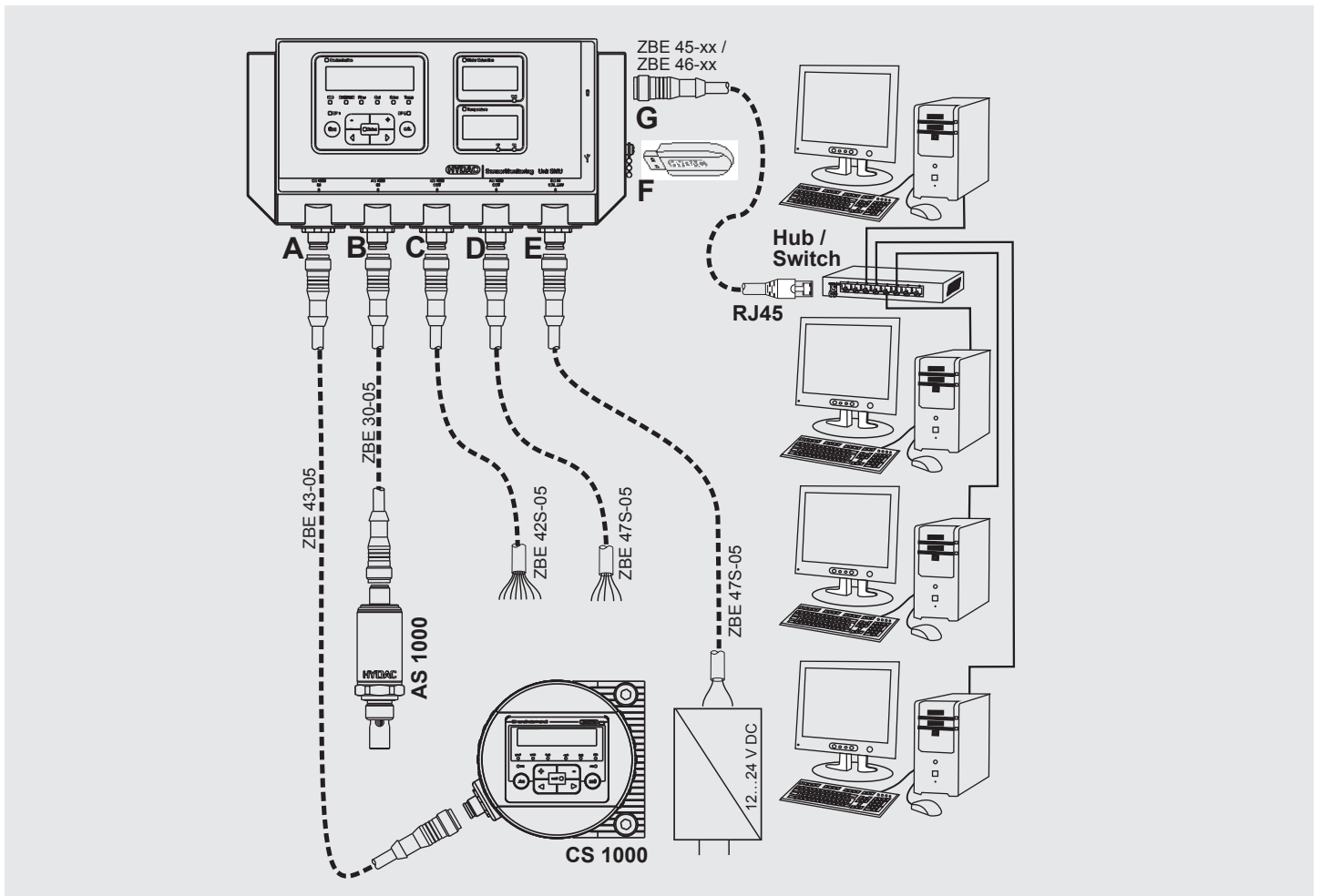

SMU1200 / CSI-B-2 / CS1000

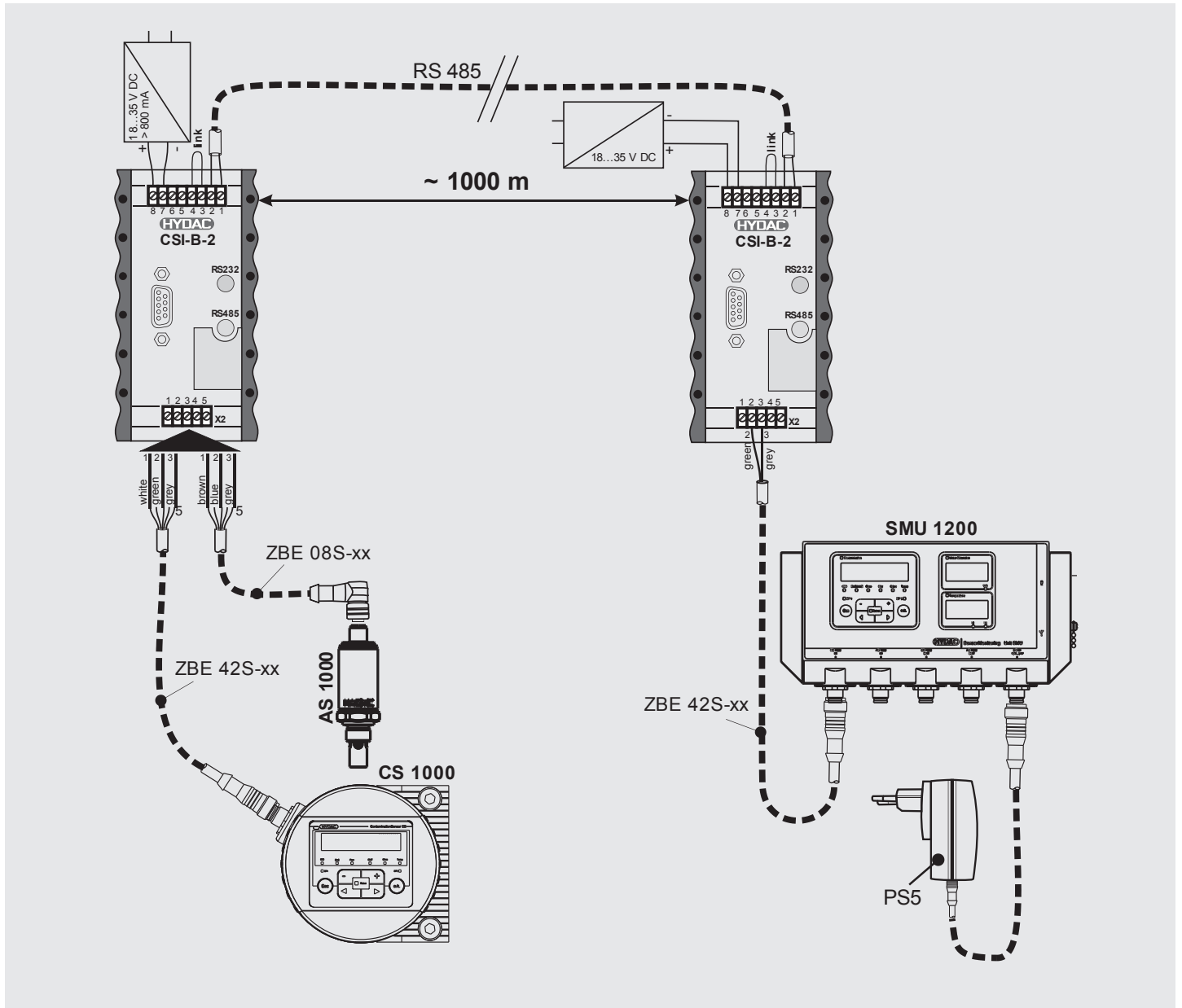

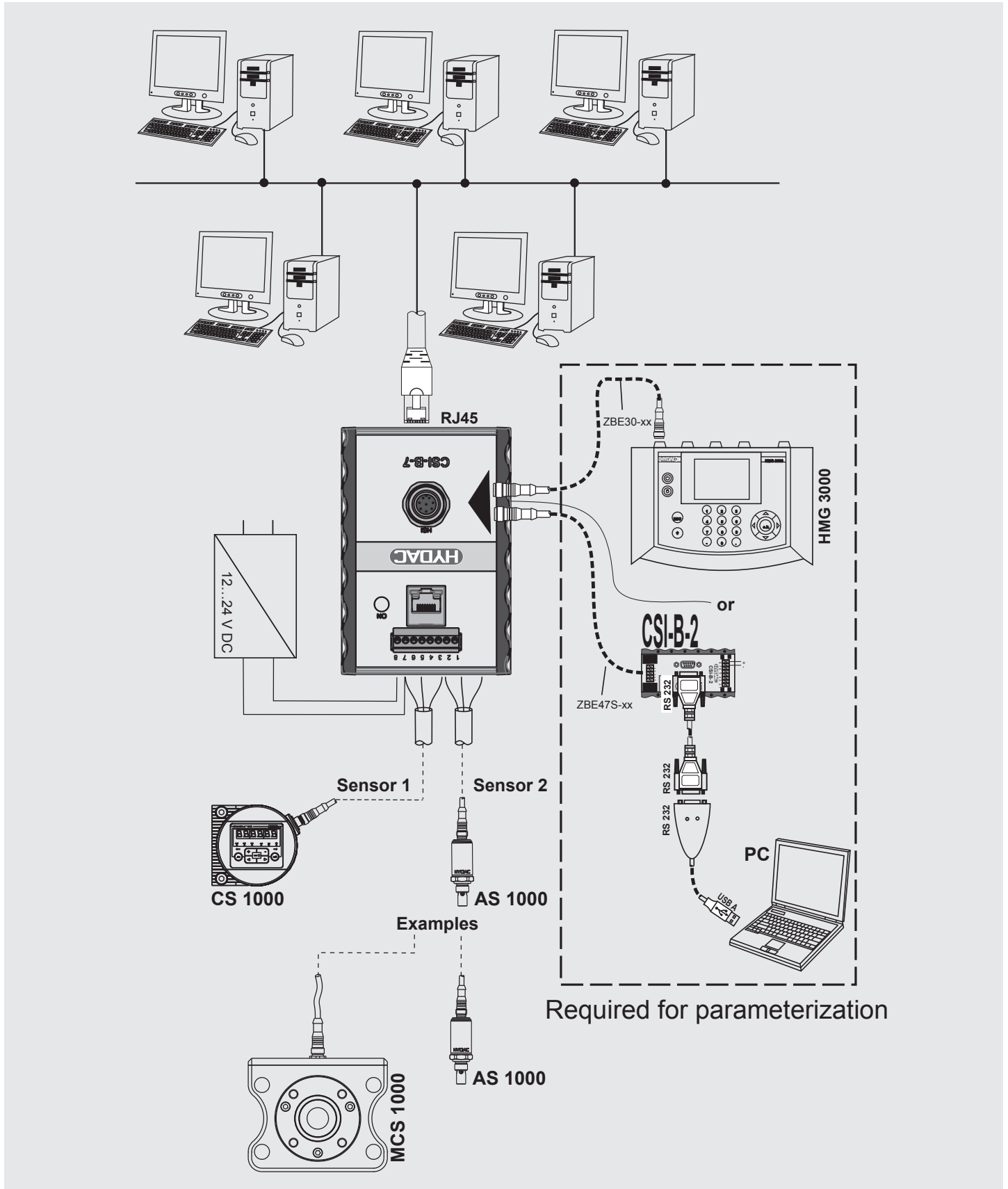

Note

The information in this brochure relates to the operating conditions and applications described. For applications and operating conditions not described, please contact the relevant technical department. Subject to technical modifications.

HYDAC FILTER SYSTEMS GMBH
 Justus-von-Liebig-Straße
D-66280 Sulzbach / Saar
 Tel.: +49 (0) 6897/509-01
 Fax: +49 (0) 6897/509-9046
 Internet: www.hydac.com
 E-Mail: filtersystems@hydac.com